

LED Tri-Proof
INSTALLATION INSTRUCTION

Model No.	Power	Voltage	CCT	Dimensions
EKTPCS36W50K-120	36W	AC220-240V , 50/60Hz	4000K,5000K,6500K	1220*100*82mm
EKTPCS54W50K-150	54W	AC220-240V , 50/60Hz	4000K,5000K,6500K	1560*100*82mm
EKTPCS65W50K-150	65W	AC220-240V , 50/60Hz	4000K,5000K,6500K	1560*100*82mm

To ensure proper usage of the lamps, please carefully read the instruction.

A Turn off the power

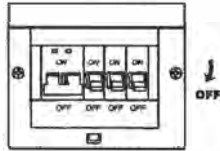

B 1 Drill $\Phi 6\text{mm}$ holes as the diagram below:

Model	Fix Hole Centre
EKTPCS36W50K-120	860mm
EKTPCS54W50K-150	1200mm
EKTPCS65W50K-150	1200mm

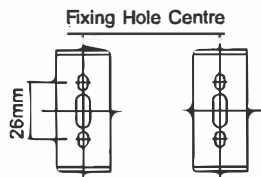

2 Insert the $\Phi 6\text{mm}$ fixing plug in to the ceiling and fix the bracket

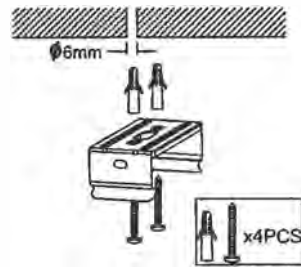

- C**
- 1 Open the clips as Fig.A
 - 2 Remove the diffuser as Fig.B
 - 3 Pinch the stainless retaining clips to remove the gear tray as Fig.C



Fig. A

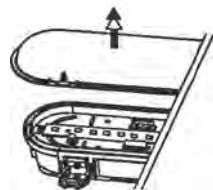

Fig. B

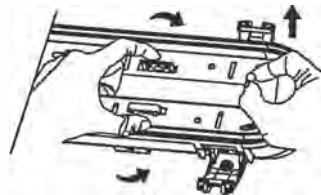
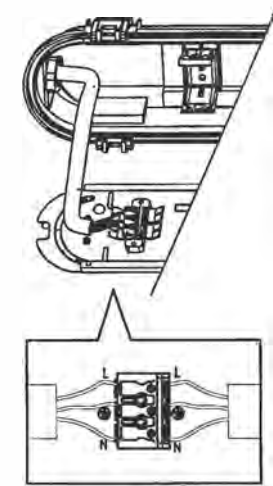
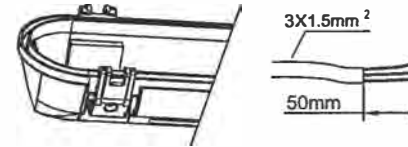
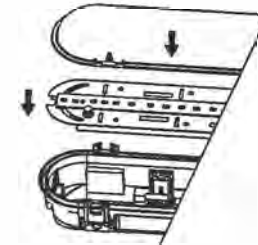

Fig. C

- D** Connect the wires ($3 \times 1.5\text{mm}^2$) to the terminal block as shown below and tighten the gland to seal the cable entry



- E**
- 1 Fit the gear tray back in to the housing
 - 2 cover the diffuser



- F** Mount the fitting in to clips fixed at Step B and insert the 4 locking screws

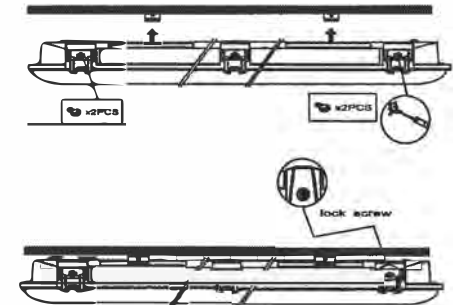

- G Turn on the power**

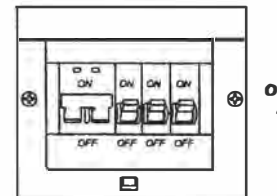

Important Safety Notice:

1. Electrical installation should only be carried out by a fully qualified electrician.
2. Never carry out any repairs while the luminaire is still connected to the mains.
3. Please do not touch the LEDs.
4. In case of malfunction, disconnect the luminaire from the supply immediately.
5. Repairs should only be carried out by authorised persons ONLY.

Sensor Setting

Wiring scheme

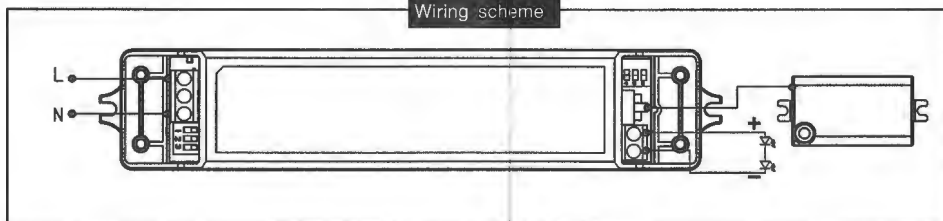

Detection Pattern

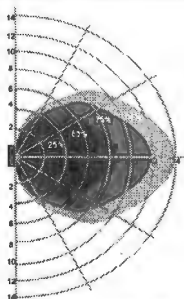

Wall mounting pattern (Unit: m)
Suggested installation height: 1-1.8m

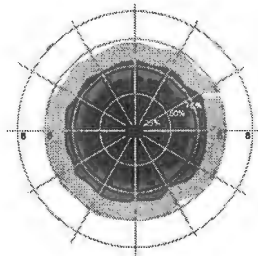

Ceiling mounting pattern (Unit: m)
Suggested installation height: 2.5-6m

Technical Parameters

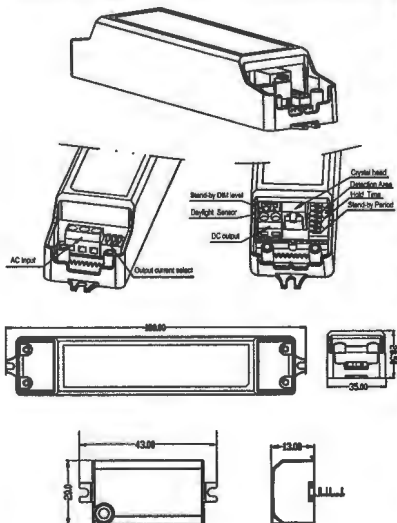

Operating voltage	220~240Vac, 50/60Hz
Output constant current	850mA
Output voltage	30-42Vdc
Efficiency	>35% (at Full load)
Power factor	0.9 (at Full load)
HF system	5.8GHz~7.5MHz, ISM wave band
Transmitting power	<0.5mW
Detection area	Max. (DxH): 12mx6m
Detection sensitivity	25%/50%/75%/100%
Hold time	5s/ 90s/ 3min/ 10min
Daylight sensor	5lux/ 15lux/ 30lux/ Disable
Stand-by DIM	0s/ 25%
Motion detection	0.5~3m/s
Detection angle	50° (Wall installation) / 90° (Ceiling installation)
Working temperature (Ta)	-25°C ~ 50°C
Size (L x W x H)	110 x 65 x 28.5mm
IP rating	IP20

Sensor Setting

By selecting the combination on the DIP switch, sensor data can be precisely set for each specific application.

ON ↑		1	2	
	I	ON	ON	100%
	II	ON	-	75%
	III	-	ON	50%
IV	-	-	-	25%

Detection area

Detection area can be reduced by selecting the combination on the DIP switches to fit precisely each application.

ON ↑		3	4	
	I	ON	ON	5s
	II	ON	-	90s
	III	-	ON	3min
IV	-	-	-	10min

Hold time

Refers to the time period the lamp remains at 100% illumination after no motion detected.

ON ↑		5	6	
	I	ON	ON	0s
	II	ON	-	30s
	III	-	ON	10min
IV	-	-	-	+∞

Corridor function (Stand-by period)

Refers to the time period the lamp remains at a low light level before it completely switches off in the long absence of people. When set to "+∞", the low light is maintained until motion is detected. When set to "0s", the light will turn off after hold time.

ON ↑		1	
	I	ON	10%
II	-	-	25%

Stand-by dimming level

The low light level you would like to have after the hold time in the long absence of people.

ON ↑		2	3	
	I	ON	ON	Disable
	II	ON	-	30Lux
	III	-	ON	15Lux
IV	-	-	-	5Lux

Daylight sensor

The sensor can be set to only allow the lamp to illuminate below a defined ambient brightness threshold.

When set to Disable mode, the daylight sensor will switch on the lamp when motion is detected regardless of ambient light level. 30Lux: twilight operation, 15lux, 5lux: darkness operation only.

EIKO-Europe GmbH
Mittelwegring 20 / 23
76751 JOCKGRIM / GERMANY
www.eiko-europe.de