

VPS LP - LOW PROFILE

Direct current electronic drivers
Alimentatori elettronici in corrente continua

constant
VOLTAGE

**RIPPLE
FREE**

KEMA 110 M M F SELV



DC 30W VPS LP



DC 75W VPS LP

ACTIVE PFC 1-2kV DIFF. 2kV COMM. SAFETY PROTECTIONS

Rated Voltage
Tensione Nominale

100 ÷ 240 V⁽²⁾
200 ÷ 240 V⁽³⁾

Frequency
Frequenza

50/60 Hz⁽²⁾
50 Hz⁽³⁾

AC Operation range

Tensione di utilizzo AC
90 ÷ 264 V⁽²⁾
180 ÷ 264 V⁽³⁾

Power
Potenza
0 ÷ 75 W

Maximum current output ripple
Max. ondulazione della corrente uscita
≤ 3%⁽¹⁾

Reference Norms
Norme di riferimento:

EN 55015
EN 62493
EN 61000-3-3
EN 61347-1
EN 61347-2-13
EN 61547
IEC 62384

Article Articolino	Code Codice	P out W	V out DC	I out DC	ta °C	tc °C	λ max. Power Factor	η max. Efficiency ⁽¹⁾
DC 30W 12V VPS LP ⁽³⁾	127900	30	12	2,5 A max.	-20...+45	80	0,96 ⁽¹⁾	> 85
DC 30W 24V VPS LP ⁽³⁾	127901	30	24	1,25 A max.	-20...+45	80	0,96 ⁽¹⁾	> 87
DC 50W 12V VPS LP ⁽²⁾	127902	50	12	4,17 A max.	-20...+45	80	0,90 ⁽⁴⁾	> 86
DC 50W 24V VPS LP ⁽²⁾	127903	50	24	2,08 A max.	-20...+45	80	0,90 ⁽⁴⁾	> 88
DC 75W 12V VPS LP ⁽²⁾	127904	75	12	6,25 A max.	-20...+45	80	0,90 ⁽⁴⁾	> 87
DC 75W 24V VPS LP ⁽²⁾	127905	75	24	3,125 A max.	-20...+45	80	0,90 ⁽⁴⁾	> 89

⁽¹⁾ Referred to $V_{in} = 230$ V, 100% load - Riferito a $V_{in} = 230$ V, carico 100%
⁽⁴⁾ Referred to $V_{in} = 230$ V, 100% load - Riferito a $V_{in} = 230$ V, carico 100%
 $\lambda > 0,95 @ V_{in} = 100$ V

Accessories not supplied - Accessori non a corredo

Article - Articolino	Code - Codice
Dimmer SED 4,5A R57	120300



Features

- AC/DC electronic driver with output in voltage, specific for installations in compliance with the standards of lighting applications.
- IP20 independent driver, for indoor use.
- Class II protection against electric shock for direct or indirect contact.
- Input and output terminal blocks on opposite sides.
- Single terminal block on primary and secondary (wire cross-section up to 0,5 - 0,75 mm² / AWG20 - AWG18).
- Driver can be secured with slot for screws.
- Protections:
 - against overheating and short circuits;
 - against mains voltage spikes;
 - against overloads.

Caratteristiche

- Alimentatore elettronico tipo AC/DC con uscita in tensione specifico per installazioni con Norme settore illuminazione.
- Alimentatore indipendente IP20, per uso interno.
- Protetto in classe II contro le scosse elettriche per contatti diretti e indiretti.
- Morsetti di entrata e uscita contrapposti.
- Singola morsettiera su primario e secondario (sezione cavo fino a 0,5 - 2,5 mm² / AWG20 - AWG18).
- Fissaggio dell'alimentatore tramite asole per viti.
- Protezioni:
 - termica e cortocircuito;
 - contro le extra-tensioni di rete;
 - contro i sovraccarichi.

5.1

Constant voltage LED drivers
Alimentatori LED a tensione costante

Direct current electronic drivers Alimentatori elettronici in corrente continua

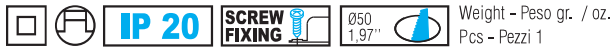

DC 30W VPS LP

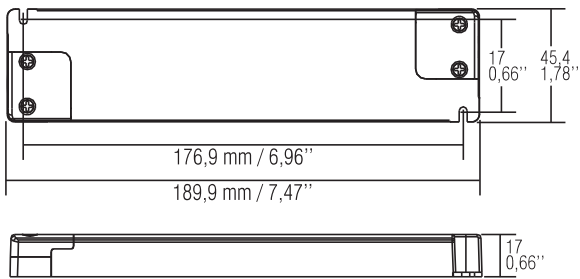

DC 50W VPS LP

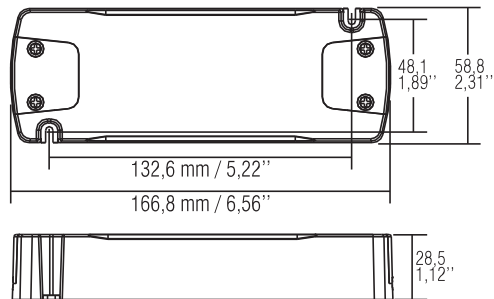

Wiring diagrams - Schemi di collegamento

(Max. LED distance at page info8 - Massima distanza LED a pagina info8)

DC 30W VPS LP

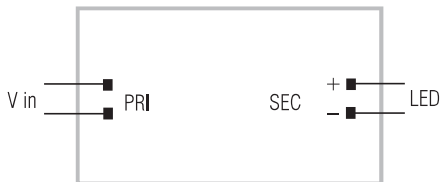

DC 50W VPS LP - DC 75W VPS LP

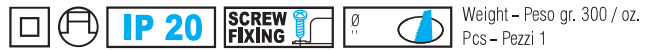
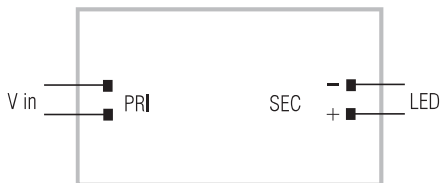

DC 75W VPS LP

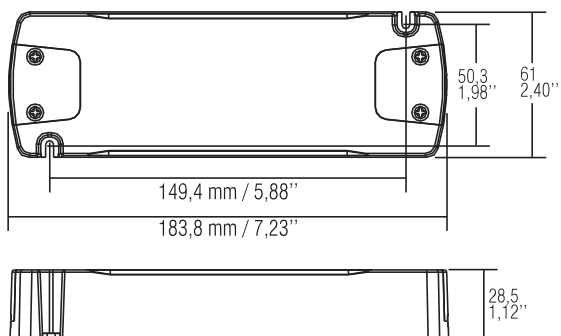

5.1

Constant voltage LED drivers
Alimentatori LED a tensione costante