

EM BASIC Ip G2, 220 – 240 V 50/60 Hz BASIC version

Product description

- Emergency lighting supply unit for manual testing
- For linear and compact fluorescent lamps
- Low-profile casing (21 x 30 mm cross-section)
- 5-year guarantee

Properties

- Non maintained operation
- 1 or 3 h rated duration
- Operating time selectable with plug (duration link)
- Compatible with all electronic ballasts (dimnable and non-dimnable)
- 5-pole technology: 4-pole lamp changeover and delayed power switching for the ballast
- High-frequency ac operation of the lamp
- Gentle on the lamp thanks to preheated lamp start and permanent cathode heating in emergency mode
- 5.5 min. boost start for rapid heating of the lamp, more light in the startup phase and optimum lamp life
- Power control technology ensures maximum emergency ballast lumen factors (EBLF) for all lamps
- Green charge status display LED
- Electronic multi-level charge system
- „Rest mode“ function
- Deep discharge protection
- Very low energy consumption from the battery after activation of the deep discharge protection
- Short-circuit-proof battery connection
- Polarity reversal protection for battery



Batteries

- High-temperature cells
- NiCd or NiMH batteries
- D- Cs- or LA cells
- 4-year design life
- 1-year guarantee
- For battery compatibility refer to chapter „Ballast-Lumen-Factor (BLF)“



Standards, page 9

Wiring diagrams and installation examples, page 12



EM BASIC Ip G2, 220 – 240 V 50/60 Hz

BASIC version

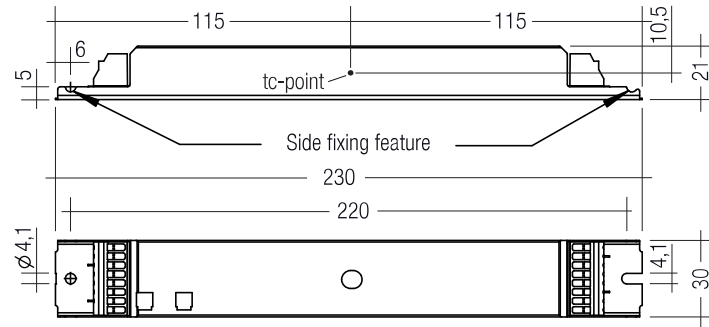

Note: Control gear supplied with duration link in 3 hours position. Remove duration link for 1 hour duration. Duration link must be set before battery and mains connection.

Technical data

Rated supply voltage	220 – 240 V
Mains frequency	50 / 60 Hz
Mains current	60 mA
Rated power	< 10 W
Overvoltage protection	320 V (for 1 h)
Maximum operating voltage (U-OUT of the ECG)	460 V
Battery charging time 1 h	10 h
Battery charging time 3 h	15 h
Discharge current	1 A
Time to light	1.2 s from detection of emergency event
Leakage current (PE)	0.5 mA
Ambient temperature t_a	-5 ... +60 °C
Max. casing temperature t_c	+70 °C
Mains voltage changeover threshold	according to EN 60598-2-22
Min. lamp starting temperature (emergency operation)	-5 °C
Type of protection	IP20
Rest mode max. number of emergency units	100
Rest mode max. wiring distance	1,000 m

Ordering data

Type	Article number	Battery type	Number of cells	Packaging, carton	Packaging, pallet	Weight per pc.
Rated operating time 1/3 h, Standard BLF						
EM 03 BASIC Ip G2	89800199	NiCd	3	10 pc(s).	700 pc(s).	0.156 kg
EM 04 BASIC Ip G2	89800202	NiCd	4	10 pc(s).	700 pc(s).	0.156 kg
EM 05 BASIC Ip G2	89800205	NiCd	5	10 pc(s).	700 pc(s).	0.156 kg
EM 06 BASIC Ip G2	89800208	NiCd	6	10 pc(s).	700 pc(s).	0.156 kg
EM 03 BASIC Ip NiMH G2	89800344	NiMH	3	10 pc(s).	700 pc(s).	0.156 kg
EM 04 BASIC Ip NiMH G2	89800345	NiMH	4	10 pc(s).	700 pc(s).	0.156 kg
EM 05 BASIC Ip NiMH G2	89800346	NiMH	5	10 pc(s).	700 pc(s).	0.156 kg
EM 06 BASIC Ip NiMH G2	89800347	NiMH	6	10 pc(s).	700 pc(s).	0.156 kg

pc(s).

Specific technical data

Type	Charge current / Battery charging time		
	Initial charge / duration	Fast recharge / duration	Trickle charge, continuously
Rated operating time 1 h, Standard BLF			
EM 03 BASIC Ip G2	130 mA / 20 h	210 mA / 10 h	50 mA
EM 04 BASIC Ip G2	130 mA / 20 h	210 mA / 10 h	50 mA
EM 05 BASIC Ip G2	130 mA / 20 h	210 mA / 10 h	50 mA
EM 06 BASIC Ip G2	130 mA / 20 h	210 mA / 10 h	50 mA
EM 03 BASIC Ip NiMH G2	130 mA / 20 h	210 mA / 10 h	130 mA / 4 min. – 0 mA / 16 min.
EM 04 BASIC Ip NiMH G2	130 mA / 20 h	210 mA / 10 h	130 mA / 4 min. – 0 mA / 16 min.
EM 05 BASIC Ip NiMH G2	130 mA / 20 h	210 mA / 10 h	130 mA / 4 min. – 0 mA / 16 min.
EM 06 BASIC Ip NiMH G2	130 mA / 20 h	210 mA / 10 h	130 mA / 4 min. – 0 mA / 16 min.
Rated operating time 3 h, Standard BLF			
EM 03 BASIC Ip G2	300 mA / 20 h	330 mA / 15 h	130 mA
EM 04 BASIC Ip G2	300 mA / 20 h	330 mA / 15 h	130 mA
EM 05 BASIC Ip G2	300 mA / 20 h	330 mA / 15 h	130 mA
EM 06 BASIC Ip G2	300 mA / 20 h	330 mA / 15 h	130 mA
EM 03 BASIC Ip NiMH G2	300 mA / 20 h	330 mA / 15 h	200 mA / 4 min. – 0 mA / 16 min.
EM 04 BASIC Ip NiMH G2	300 mA / 20 h	330 mA / 15 h	200 mA / 4 min. – 0 mA / 16 min.
EM 05 BASIC Ip NiMH G2	300 mA / 20 h	330 mA / 15 h	200 mA / 4 min. – 0 mA / 16 min.
EM 06 BASIC Ip NiMH G2	300 mA / 20 h	330 mA / 15 h	200 mA / 4 min. – 0 mA / 16 min.

RoHS

ACCESSORIES

Test switch EM3

Product description

- For connection to the emergency lighting unit
- For checking the device function
- Plug connection



Ordering data

Type	Article number	Packaging, bag	Packaging, carton	Weight per pc.
Test switch EM 3	89899956	25 pc(s).	200 pc(s).	0.013 kg

ACCESSORIES

Status indication green LED

Product description

- A green LED indicates that charging current is flowing into the battery
- Plug connection



Ordering data

Type	Article number	Packaging, bag	Packaging, carton	Weight per pc.
LED EM green, 1.0 m CON	89800269	25 pc(s).	200 pc(s).	0.015 kg
LED EM green, HO 1.0 m CON	89800271	25 pc(s).	200 pc(s).	0.015 kg
LED EM green, 0.6 m CON	89800472	25 pc(s).	200 pc(s).	0.009 kg
LED EM green, HO 0.6 m CON	89800473	25 pc(s).	200 pc(s).	0.009 kg
LED EM green, 0.3 m CON	89800270	25 pc(s).	200 pc(s).	0.005 kg
LED EM green, HO 0.3 m CON	89800272	25 pc(s).	200 pc(s).	0.005 kg

Ballast lumen factor (BLF) in %

EM BASIC Ip G2 for linear lamps, 3 or 1 h

Lamp type	Duration	1/3 h Standard BLF							
		3 cells	4 cells	5 cells	6 cells	3 cells	4 cells	5 cells	6 cells
		EM 03 BASIC Ip G2	EM 04 BASIC Ip G2	EM 05 BASIC Ip G2	EM 06 BASIC Ip G2	EM 03 BASIC Ip NiMH G2	EM 04 BASIC Ip NiMH G2	EM 05 BASIC Ip NiMH G2	EM 06 BASIC Ip NiMH G2
Art. no.	89800199	89800202	89800205	89800208	89800344	89800345	89800346	89800347	
Wattage		BLF in emergency lighting mode in % for rated operating time							
T5	6 W								
	8 W	32.4	40.0			32.4	40.0		
	13 W								
ECO T5	13 W		22.0				22.0		
	20 W		15.4				15.4		
	25 W				16.8				16.8
	32 W				13.4				13.4
	45 W				8.1				8.1
	50 W				5.8				5.8
	73 W				4.1				4.1
T5 FH	14 W		24.0				24.0		
	21 W			18.0				18.0	
	28 W				15.0				15.0
	35 W				11.0				11.0
T5 FQ	24 W		15.6				15.6		
	39 W				10.0				10.0
	49 W				6.7				6.7
	54 W				5.3				5.3
	80 W				4.2				4.2
T8	15 W		17.0				17.0		
	18 W		18.0				18.0		
	30 W								
	36 W		11.0				11.0		
	38 W								
	58 W			7.5				7.5	
70 W				4.5				4.5	

Technology and capacity	Design	Number of cells	Type	Article number	Assignable batteries								
NiCd 4 Ah D cells	Stick	3	Accu-NiCd 3A	89895960	3 h								
	Side by side	3	Accu-NiCd 3B 55	89800384	3 h								
	Stick	4	Accu-NiCd 4A 55	89800089		3 h							
	Side by side	4	Accu-NiCd 4B 55	89800385		3 h							
	Stick + Stick	2 + 2	Accu-NiCd 4C	89895978		3 h							
	Stick	5	Accu-NiCd 5A	89895973			3 h						
	Stick + Stick	2 + 3	Accu-NiCd 5C 55	89800090			3 h						
NiMH 2 Ah Cs cells	Stick + Stick	3 + 3	Accu-NiCd 6C 55	89800388				3 h					
	Stick	3	Accu-NiMH C 3A	89899744	1 h				1 h				
	Stick	4	Accu-NiMH C 4A	89899700			1 h			1 h			
	Stick	5	Accu-NiMH C 5A	89899703				1 h			1 h		
	Stick	6	Accu-NiMH C 6A	89899706				1 h				1 h	
NiMH 4 Ah LA cells	Stick + Stick	3 + 3	Accu-NiMH C 6C	89899707				1 h				1 h	
	Stick	3	Accu-NiMH 4Ah 3A CON	89800441					3 h				
	Stick	4	Accu-NiMH 4Ah 4A CON	89800442						3 h			
	Stick + Stick	2 + 2	Accu-NiMH 4Ah 4C CON	89800438						3 h			
	Stick + Stick	2 + 3	Accu-NiMH 4Ah 5C CON	89800439							3 h		
Stick + Stick	3 + 3	Accu-NiMH 4Ah 6C CON	89800440									3 h	

Ballast lumen factor (BLF) in %

EM BASIC Ip G2 for compact lamps, 3 or 1 h

Lamp type	Duration	1/3 h Standard BLF							
		3 cells	4 cells	5 cells	6 cells	3 cells	4 cells	5 cells	6 cells
Type		EM 03 BASIC Ip G2	EM 04 BASIC Ip G2	EM 05 BASIC Ip G2	EM 06 BASIC Ip G2	EM 03 BASIC Ip NiMH G2	EM 04 BASIC Ip NiMH G2	EM 05 BASIC Ip NiMH G2	EM 06 BASIC Ip NiMH G2
Article no.		89800199	89800202	89800205	89800208	89800344	89800345	89800346	89800347
Lamp type		Wattage							
		BLF in emergency lighting mode in % for rated operating time							
TC-DD	10 W								
	16 W		23.6				23.6		
	21 W		15.4				15.4		
	28 W		13.7				13.7		
	38 W					10.3			10.3
	55 W					5.9			5.9
TC-SEL	7 W								
	9 W	18.3	27.6			18.3	27.6		
	11 W	17.4	31.0			17.4	31.0		
TC-DEL	10 W								
	13 W	18.6	25.6			18.6	25.6		
	18 W		17.0				17.0		
	26 W		14.4				14.4		
TC-TEL [®]	13 W	17.0 / 10.9	25.2 / 17.1			17.0 / 10.9	25.2 / 17.1		
	18 W		17.5 / 14.1	17.8 / 21.0			17.5 / 14.1	17.8 / 21.0	
	26 W [®]		11.5 / 10.0	13.0	14.0		11.5 / 10.0	13.0	14.0
	32 W [®]			14.0 / 5.6	x / 8.0			14.0 / 5.6	x / 8.0
	42 W				7.4 / 7.3				7.4 / 7.3
	57 W								
T5c	22 W		16.9				16.9		
	40 W					7.4			7.4
	55 W					5.1			5.1
TC-F	18 W		18.0				18.0		
	24 W			21.0				21.0	
	36 W			13.0				13.0	
TC-L	18 W		17.4				17.4		
	24 W			17.0				17.0	
	36 W			12.0				12.0	
	40 W			8.8				8.8	
	55 W					5.4			5.4
TC-R	14 W		20.0				20.0		
	17 W		15.0				15.0		

Technology and capacity	Design	Number of cells	Type	Article number	Assignable batteries				
NiCd 4 Ah D cells [®]	Stick	3	Accu-NiCd 3A	89895960	3 h				
	Side by side	3	Accu-NiCd 3B 55	89800384	3 h				
	Stick	4	Accu-NiCd 4A 55	89800089		3 h			
	Side by side	4	Accu-NiCd 4B 55	89800385		3 h			
	Stick + Stick	2 + 2	Accu-NiCd 4C	89895978		3 h			
	Stick	5	Accu-NiCd 5A	89895973			3 h		
	Stick + Stick	3 + 2	Accu-NiCd 5C 55	89800090			3 h		
NiMH 2 Ah Cs cells	Stick + Stick	3 + 3	Accu-NiCd 6C 55	89800388			3 h		
	Stick	3	Accu-NiMH C 3A	89899744	1 h			1 h	
	Stick	4	Accu-NiMH C 4A	89899700		1 h		1 h	
	Stick	5	Accu-NiMH C 5A	89899703			1 h		1 h
	Stick	6	Accu-NiMH C 6A	89899706			1 h		1 h
NiMH 4 Ah LA cells	Stick + Stick	3 + 3	Accu-NiMH C 6C	89899707			1 h		1 h
	Stick	3	Accu-NiMH 4Ah 3A CON	89800441				3 h	
	Stick	4	Accu-NiMH 4Ah 4A CON	89800442				3 h	
	Stick + Stick	2 + 2	Accu-NiMH 4Ah 4C CON	89800438				3 h	
	Stick + Stick	2 + 3	Accu-NiMH 4Ah 5C CON	89800439					3 h
Stick + Stick	3 + 3	Accu-NiMH 4Ah 6C CON	89800440					3 h	

[®] The first figure is related to non-amalgam lamps, the second figure is related to amalgam lamps (e.g. 14 / 9.5).

[®] For best performance of 26W and 32W TC lamps, and especially amalgam filled lamps, we recommend the use of EM 06 BASIC Ip G2.

Emergency Ballast Lumen Factor (EBLF) in %^①

EM BASIC Ip G2, 3 or 1 h

	Duration	1/3 h Standard BLF							
		3 cells	4 cells	5 cells	6 cells	3 cells	4 cells	5 cells	6 cells
Type		EM 03 BASIC Ip G2	EM 04 BASIC Ip G2	EM 05 BASIC Ip G2	EM 06 BASIC Ip G2	EM 03 BASIC Ip NiMH G2	EM 04 BASIC Ip NiMH G2	EM 05 BASIC Ip NiMH G2	EM 06 BASIC Ip NiMH G2
Article no.		89800199	89800202	89800205	89800208	89800344	89800345	89800346	89800347
Lamp type	Wattage	EBLF in emergency lighting mode in % for rated operating time							
T5	6 W								
	8 W	29.0	36.0			29.0	36.0		
	13 W								
ECO T5	13 W		19.7				19.7		
	20 W		13.9				13.9		
	25 W				14.9				14.9
	32 W				11.9				11.9
	45 W				7.3				7.3
	50 W				5.9				5.9
	73 W				4.1				4.1
T5 FH	14 W		22.0				22.0		
	21 W			17.0				17.0	
	28 W				14.0				14.0
	35 W				10.5				10.5
T5 FQ	24 W		14.1				14.1		
	39 W				9.1				9.1
	49 W				6.4				6.4
	54 W				5.7				5.7
T8	80 W				4.2				4.2
	15 W		16.0				16.0		
	18 W		16.5				16.5		
	30 W								
	36 W		10.2				10.2		
	38 W								
TC-DD	58 W			6.5				6.5	
	70 W				3.7				3.7
	10 W								
	16 W		20.0				20.0		
	21 W		13.9				13.9		
	28 W		12.2				12.2		
TC-SEL	38 W				8.9				8.9
	55 W				5.5				5.5
	7 W								
	9 W	13.6	21.8			13.6	21.8		
TC-DEL	11 W	16.0	28.0			16.0	28.0		
	10 W								
TC-DEL	13 W	13.9	21.3			13.9	21.3		
	18 W		15.5				15.5		
	26 W		13.0				13.0		
	10 W								
TC-TEL [®]	13 W	14.3 / 8.2	21.8 / 9.7			14.3 / 8.2	21.8 / 9.7		
	18 W		14.5 / 8.6	15.3 / 14.1			14.5 / 8.6	15.3 / 14.1	
	26 W [®]		10.4 / 8.5	9.7	11.9		10.4 / 8.5	9.7	11.9
	32 W [®]			12.8 / 4.8	x / 7.7			12.8 / 4.8	x / 7.7
	42 W				7.2 / 6.7				7.2 / 6.7
	57 W								
T5c	22 W		14.7				14.7		
	40 W				7.7				7.7
	55 W				4.4				4.4
TC-F	18 W		16.5				16.5		
	24 W			19.5				19.5	
	36 W			12.0				12.0	
TC-L	18 W		15.3				15.3		
	24 W			15.5				15.5	
	36 W			10.5				10.5	
	40 W			8.4				8.4	
	55 W				4.8				4.8
TC-R	14 W		18.2				18.2		
	17 W		13.3				13.3		

^① According to EN 61347-2-7: 2006

[®] The first figure is related to non-amalgam lamps, the second figure is related to amalgam lamps (e.g. 14 / 9.5).

[®] For best performance of 26 W and 32 W TC lamps, and especially amalgam filled lamps, we recommend the use of EM 06 BASIC Ip G2.

Lamp current in emergency operation in mA

EM BASIC Ip G2, 3 or 1 h

	Duration	1/3 h Standard BLF							
	Cells	3 cells	4 cells	5 cells	6 cells	3 cells	4 cells	5 cells	6 cells
Type	EM 03 BASIC Ip G2	EM 04 BASIC Ip G2	EM 05 BASIC Ip G2	EM 06 BASIC Ip G2	EM 03 BASIC Ip NiMH G2	EM 04 BASIC Ip NiMH G2	EM 05 BASIC Ip NiMH G2	EM 06 BASIC Ip NiMH G2	
Article no.	89800199	89800202	89800205	89800208	89800344	89800345	89800346	89800347	
Lamp type	Wattage	Lamp current in emergency operation in mA for rated operating time							
T5	6 W								
	8 W	315	400			315	400		
	13 W								
ECO T5	13 W		34.0				34.0		
	20 W		34.2				34.2		
	25 W				24.0				24.0
	32 W				20.3				20.3
	45 W				17.2				17.2
	50 W				12.9				12.9
	73 W				15.4				15.4
T5 FH	14 W		26.0				26.0		
	21 W			22.0				22.0	
	28 W				19.0				19.0
	35 W				15.0				15.0
T5 FQ	24 W		32.9				32.9		
	39 W				19.2				19.2
	49 W				14.0				14.0
	54 W				12.0				12.0
	80 W				15.2				15.2
T8	15 W		42.0				42.0		
	18 W		38.0				38.0		
	30 W		26.3				26.3		
	36 W								
	38 W								
	58 W			22.8				22.8	
	70 W				13.0				13.0
TC-DD	10 W								
	16 W		29.5				29.5		
	21 W		34.2				34.2		
	28 W		22.9				22.9		
	38 W				21.8				21.8
	55 W				20.5				20.5
TC-SEL	7 W								
	9 W	35.8	44.5			35.8	44.5		
	11 W	28.0	32.0			28.0	32.0		
TC-DEL	10 W								
	13 W	26.8	30.4			26.8	30.4		
	18 W		31.4				31.4		
	26 W		20.0				20.0		
TC-TEL [®]	13 W	27.0 / 26.0	32.5 / 31.8			27.0 / 26.0	32.5 / 31.8		
	18 W		31.9 / 31.4	32.4 / 32.3			31.9 / 31.4	32.4 / 32.3	
	26 W		26.7	29.9	29.9		26.7	29.9	29.9
	32 W			21.0 / 19.0	x / 17.0			21.0 / 19.0	x / 17.0
	42 W				14.0 / 12.0				14.0 / 12.0
	57 W								
T5c	22 W		30.1				30.1		
	40 W				16.4				16.4
	55 W				16.3				16.3
TC-F	18 W		40.0				40.0		
	24 W			42.0				42.0	
	36 W			26.0				26.0	
TC-L	18 W		41.4				41.4		
	24 W			36.0				36.0	
	36 W			25.0				25.0	
	40 W			16.0				16.0	
	55 W				16.4				16.4
TC-R	14 W		20.9				20.9		
	17 W		15.4				15.4		

[®] The first figure is related to non-amalgam lamps, the second figure is related to amalgam lamps (e.g. 15/16).

Standards

- according to EN 50172
- according to EN 60598-2-22
- EN 61347-2-7
- EN 60925
- EN 55015
- EN 61000-3-2
- EN 61000-3-3
- EN 61547
- EN 60068-2-64
- EN 60068-2-29
- EN 60068-2-30

Isolation and electric strength testing of luminaires

Electronic devices can be damaged by high voltage. This has to be considered during the routine testing of the luminaires in production.

According to IEC 60598-1 Annex Q (informative only!) or ENEC 303-Annex A, each luminaire should be submitted to an isolation test with 500 VDC for 1 second. This test voltage should be connected between the interconnected phase and neutral terminals and the earth terminal. The isolation resistance must be at least 2 MΩ.

As an alternative, IEC 60598-1 Annex Q describes a test of the electrical strength with 1,500 VAC (or 1,414 x 1,500 VDC). To avoid damage to the electronic devices this test must not be conducted.

Technical data batteries**Accu-NiCd****4.2 / 4.5 Ah**

Battery voltage/cell	1.2V
Cell type	D
Case temperature range to ensure 4 years design life	+5 °C to +55 °C
Max. short term temperature (reduced life-time)	70 °C
Max. number discharge cycles	4 cycles per year plus 4 cycles during commissioning
Max. storage time	6 months

Accu-NiMh**2.0 Ah**

Battery voltage/cell	1.2V
Cell type	Cs
Case temperature range to ensure 4 years design life	+5 °C to +55 °C
Max. short term temperature (reduced life-time)	70 °C
Max. number discharge cycles	4 cycles per year plus 30 cycles during commissioning
Max. storage time	6 months

4.0 Ah

Battery voltage/cell	1.2V
Cell type	LA
Case temperature range to ensure 4 years design life	+5 °C to +45 °C
Max. short term temperature (reduced life-time)	70 °C
Max. number discharge cycles	4 cycles per year plus 30 cycles during commissioning
Max. storage time	6 months

For further informations refer to corresponding battery datasheet.

Storage, installation and commissioning

Relevant information about storage conditions, installation and commissioning are provided in the battery datasheets.

Ballast compatibility

The EM BASIC Ip G2 emergency units use 5 pole technology and are compatible with most high frequency ballasts on the market, however it is important to check that the U-OUT rating of the ballast does not exceed the value specified under "Technical data".

Note

Basic insulation between supply and battery circuit.

Life-time

Average life-time 50,000 hours under rated conditions with a failure rate of less than 10 %. Average failure rate of 0.2 % per 1000 operating hours.

Mechanical details

Channel manufactured from galvanised steel.
Cover manufactured from white pre-coated steel.

LED status indicator

- Green
- Mounting hole 6.5 mm dia
- Lead length 0.3 m / 1.0 m
- Insulation rating: 90 °C
- Plug connection

Test switch

- Mounting hole 7.0 mm dia
- Lead length 0.55 m
- Plug connection

Battery leads

- Quantity: 1 red and 1 black
- Length: 1.3 m
- Wire type: 0.5 mm² solid conductor
- Insulation rating: 90 °C

Battery end termination

Push on 4.8 mm receptacle to suit battery spade fitted with insulating cover

Module end termination

8.0 mm stripped insulation

Two-piece batteries are supplied with a 200 mm lead with 4.8 mm receptacle at each end and insulating covers to connect the separate sticks together.

Rest mode

Rest mode can be initiated by applying a short pulse of between 9.5 VDC and 22.5 VDC in amplitude for a period of between 150 ms and 1.0 second. This should be applied to terminals marked Rest after the mains supply has been disconnected and whilst the module is in emergency operation. After a mains reset the EM BASIC Ip G2 exits the rest mode. The EM BASIC Ip G2 supports the re-light function.

The Rest mode terminals are not sensitive to polarity.

Pulse/Mode	Standby	Emergency	Rest
150 – 1,000 ms	Inhibit	Rest	–
1,001 – 2,000 ms	Cancel inhibit	–	re-light

Batteries

Connection method: 4.8 x 0.5 mm spade tag welded to end of cell.

For stick packs this connection is accessible after the battery caps have been fitted.

To inhibit inverter operation disconnect the batteries by removing the connector from the battery spade tag.

For battery data see separate data sheet.

Electrical connections

An earthed starting aid is recommended. The module should be earthed by the fixings used to attach it to the luminaire.

Wiring

Lamp/ballast/supply

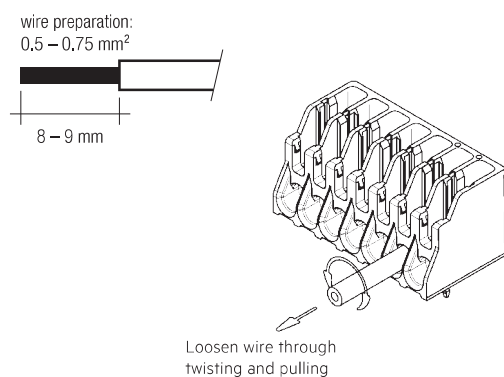

IDC interface

- solid wire with a cross section of 0.5 mm² according to the specification from IDC terminals

Maximum lamp lead capacitance

terminals 5 and 6 (* hot leads) 100 pF ¹⁾
terminals 3 and 4 200 pF ¹⁾

¹⁾ Note: care should be taken not to exceed the total maximum lamp lead capacitance for HF ballast. Leads should always be kept as short as possible.

Duration link selection

Duration	Usage duration link
3 h	 With link
1 h	 Without link

Control gear supplied with duration link in 3 hours position.

The position of the link will only be read on first power up. If it is changed afterwards both the battery and mains supply must be disconnected for 10 seconds to enable the EM BASIC Ip G2 to read the new link position on reconnection of the battery and mains. It will lead to a false battery failure indication if the link is changed after installation without this reset.

Wiring guidelines

To ensure that a luminaire containing high frequency emergency units complies with EN 55015 for radio frequency conducted interference in both normal and emergency mode it is essential to follow good practice in the wiring layout.

Within the luminaire the switched and unswitched 50 Hz supply wiring must be routed as short as possible and be kept as far away as possible from the lamp leads.

This means, for example, in a linear T8 or T5 luminaire the mains wiring should be routed along one side of the luminaire body, while the wires to the emergency lamp from the emergency module are routed along the other side.

The high frequency emergency lamp wiring contains "hot" leads at pins 5 and 6, which have high voltage to earth. These should be kept as short as possible and separated from other wiring to minimize coupling. They also have a restriction on capacitance to other wiring and earth of 100 pF, which must be observed to ensure good lamp starting.

With an earth connection of the metal case of the emergency module the noise suppression can be further improved. The wiring of the earth should be kept as short as possible.

Through wiring may affect the emc performance of the luminaire.

With the use of the fifth pole possible compatibility problems between the products can be prevented. Depending on the luminaire wiring the radio suppression in the emergency mode of operation can be further improved.

Capacitive loading limits of lamp leads must not be exceeded. Note the capacitance of the emergency lamp leads adds to the capacitance of the leads from the ballast to the EM BASIC Ip G2 module when considering ballast loading.

The LED and test switch wiring should be routed separately and kept as far away as possible from the high frequency lamp leads to avoid coupling.

Maximum loading of automatic circuit breakers

Automatic circuit breaker type	B10	B13	B16	B20	C10	C13	C16	C20	Inrush current	
Installation Ø	1.5 mm ²	1.5 mm ²	1.5 mm ²	2.5 mm ²	1.5 mm ²	1.5 mm ²	1.5 mm ²	2.5 mm ²	I_{max}	time
EM 03 BASIC Ip G2	90	130	130	130	180	260	260	260	10 A	120 µs
EM 04 BASIC Ip G2	90	130	130	130	180	260	260	260	10 A	120 µs
EM 05 BASIC Ip G2	90	130	130	130	180	260	260	260	10 A	120 µs
EM 06 BASIC Ip G2	90	130	130	130	180	260	260	260	10 A	120 µs
EM 03 BASIC Ip NiMH G2	90	130	130	130	180	260	260	260	10 A	120 µs
EM 04 BASIC Ip NiMH G2	90	130	130	130	180	260	260	260	10 A	120 µs
EM 05 BASIC Ip NiMH G2	90	130	130	130	180	260	260	260	10 A	120 µs
EM 06 BASIC Ip NiMH G2	90	130	130	130	180	260	260	260	10 A	120 µs

EM FLT1 filter

When the EM BASIC Ip G2 is used in a remote application, where the lamp leads and LED indicator leads are routed together in close proximity, it is possible to have electrical interference picked up in the indicator leads.

Under certain conditions this interference can cause a lock-up of the EM BASIC Ip G2 micro-controller.

To overcome this problem in such applications it is necessary to fit the filter EM FLT1 between the indicator LED and the EM BASIC Ip G2 unit. To be effective the filter must be connected close to the EM BASIC Ip G2 module.

For further information please contact Tridonic.

Technical data:

Push wire terminals 0.5–1.5 mm² solid conductor

Ordering data

Type	Article number	Packaging, carton	Packaging, pallet	Weight per pcs.
EM FLT1	89899942	50 pc(s)	1,000 pc(s)	0.022 kg

EM FLT1 filter

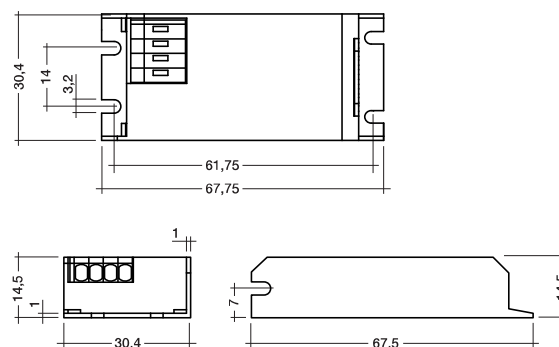

Circuit diagram with EM FLT1 filter

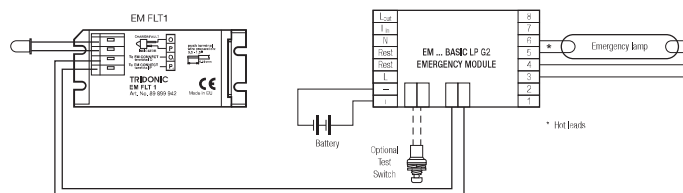

EM ... BASIC LP G2 emergency module wiring diagrams

Not for use with magnetic ballasts and switch start circuits

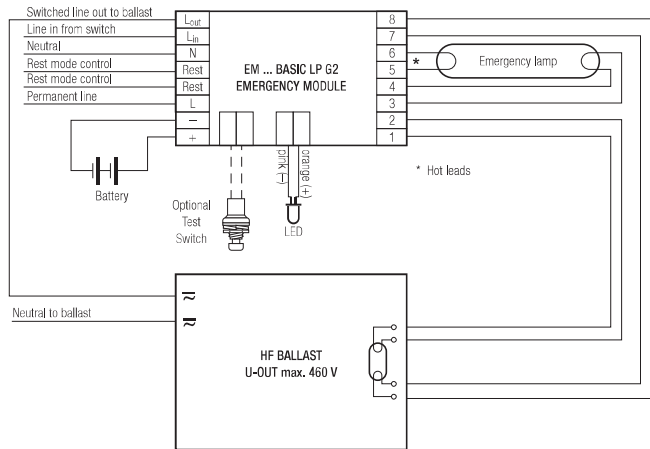

Wiring diagram for single lamp high frequency ballasts

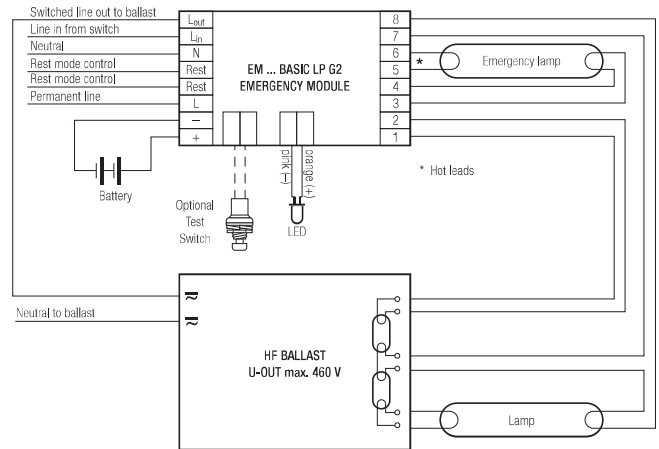

Wiring diagram for twin lamp high frequency ballasts with 6 terminals

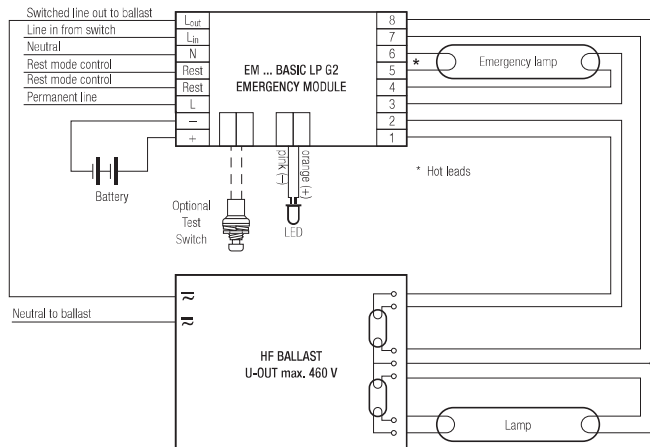

Wiring diagram for twin lamp high frequency ballasts with 7 terminals

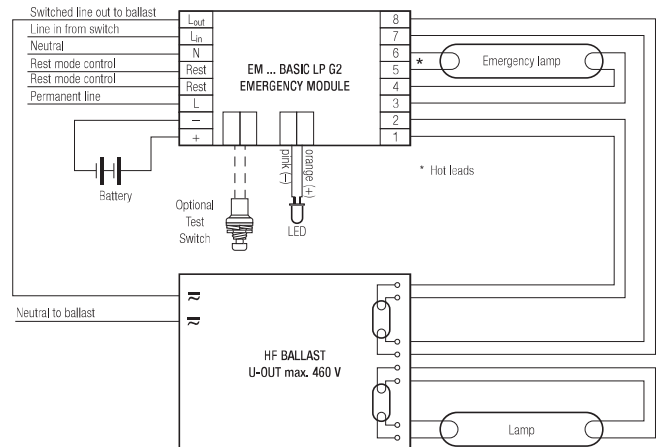

Wiring diagram for twin lamp high frequency ballasts with 8 terminals

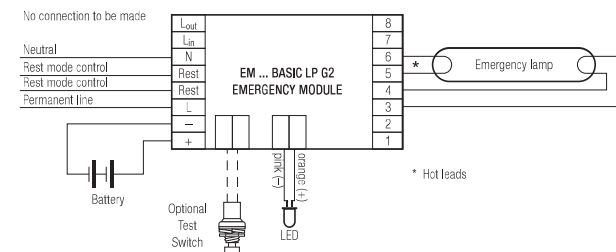

Wiring diagram for non-maintained operation

Note:

All hot leads normally marked with an * should be kept as short as possible. For comprehensive wiring diagrams and instructions consult the Tridonic website www.tridonic.com

Additional information

Additional technical information at www.tridonic.com → Technical Data

Guarantee conditions at www.tridonic.com → Services

Life-time declarations are informative and represent no warranty claim. No warranty if device was opened.