









iHF 3D

COM1 - anthracite
 EAN 4007841 066178
 Article number 066178



		2000 W							Teach
intelligent high frequency sensor 160°	3 zones scalable 3 x 1-7m, max. 7 m	2000 W max. (LED-ready)	IP54	2 - 2000 lux	5 sec - 60 min (via App)	manual override 4h	connectable via bluetooth	Ideal 2 m	Teach mode

Function description

Makes all the difference outside. Precisely where you want it to. iHF 3D motion detector, ideal for facades, carports, parking areas and patios. 160° iHF-sensor with 7 m reach, 3D aerial technology, identifies and distinguishes between moving objects, no inadvertent triggering any more by small animals, very low or high temperatures. Detects everything equally well whichever direction it is approached from. Easy to adjust and interconnect by app and Bluetooth.

Technical specifications

Type	Motion detectors	Twilight setting TEACH	Yes
Dimensions (L x W x H)	120 x 117 x 120 mm	Twilight setting	2 – 2000 lx
Mains power supply	220 – 240 V / 50 – 60 Hz	Time setting	5 s – 60 Min.
Sensor Technology	iHF (intelligent high-frequency technology)	Switching output 1, resistive	2000 W
Application, place	Outdoors	Constant-lighting control	No
Installation site	wall	Basic light level function	No
Installation	Surface wiring	Functions	Normal / test mode, Manual ON / ON-OFF
Mounting height	1,80 – 2,00 m	Settings via	Potentiometers, Bluetooth
Reach, radial	r = 7 m (68 m ²)	Interconnection	Yes
Reach, tangential	r = 7 m (68 m ²)	Type of interconnection	Master/master
Reach, detail	Detection zone adjustable on 3 axes	IP-rating	IP54
HF-system	5,8 GHz	Material	Plastic
Detection angle	160 °	Ambient temperature	-20 – 50 °C
Angle of aperture	100 °	Application, room	outdoors, front door, all round the building, terrace / balcony, courtyard & driveway
Optimum mounting height	1,8 m	Colour	Anthracite
Mechanical scalability	No	Colour, RAL	7016
Sneak-by guard	Yes	Manufacturer's Warranty	5 years
Capability of masking out individual segments	Yes	Version	COM1 - anthracite
Electronic scalability	Yes	PU1, EAN	4007841066178

iHF 3D

COM1 - anthracite

EAN 4007841 066178

Article number 066178

Detection Zone

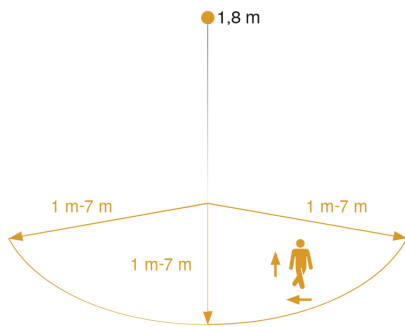

Mögliche Montagehöhe: 1,80 m – 2,00 m

Orange: radial und tangential

3 skalierbare Achsen

Dimension Drawing

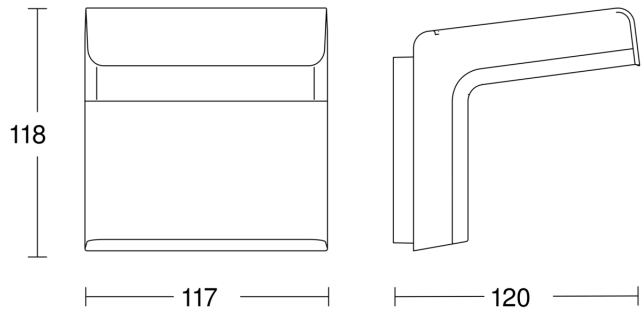

Master circuit diagram

