

PRODUCT DATASHEET

DL ALU DN 150 14 W 3000 K IP44/IP20 WT

DOWNLIGHT ALU | Downlight luminaires with aluminum housing



Areas of application

- Direct replacement for luminaires with compact fluorescent lamps
- General illumination
- Public areas
- Stairways
- Corridors
- Foyers
- Shops

Product benefits

- High luminous efficacy
- Energy savings up to 60 % (compared to luminaires that use CFL lamps)
- Very homogenous light
- Functional design
- Easy installation with fast connection
- External driver for extended flexibility (compatible with selected DALI drivers)
- 5 years guarantee

Product features

- Diameter of required ceiling cut-out: 150 mm or 200 mm (depending on version)
- Type of protection: IP44



TECHNICAL DATA

Electrical data

Nominal wattage	14.00 W
Nominal voltage	220...240 V
Mains frequency	50...60 Hz
Nominal current	100 mA
Inrush current	4 A
Max. no. of lum. on circuit break. B16 A	128
Max. no. of lum. on circuit break. C10 A	80
Max. no. of lum. on circuit break. C16 A	128
Power factor λ	> 0.90
Total harmonic distortion	< 20 %
Protection class	II
Operating mode	External LED driver

Photometrical data

Luminous flux	1190 lm
Luminous efficacy	85 lm/W
Color temperature	3000 K
Light color (designation)	Warm White
Color rendering index Ra	> 80
Standard deviation of color matching	≤ 6 sdc _m
Flickering metric (Pst LM)	-
Stroboscope effect metric (SVM)	-
Photobiological safety group acc. to EN62778	RG0
Photobiological safety group acc. to EN62471	RG0
Beam angle	100 °



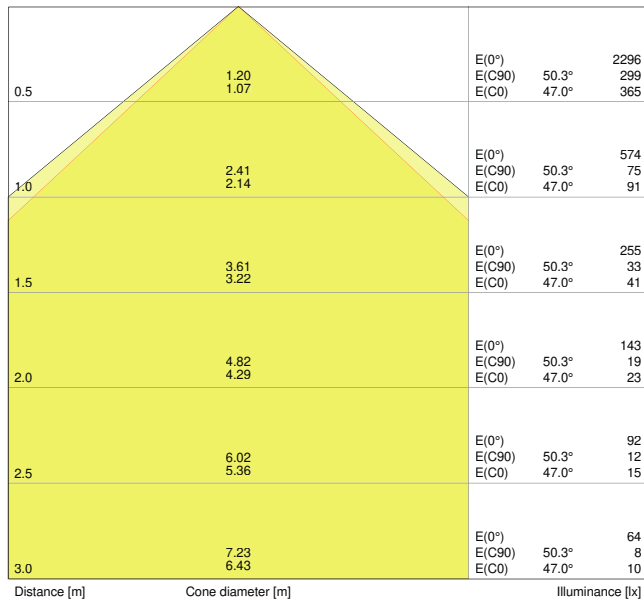

LDC typ cone

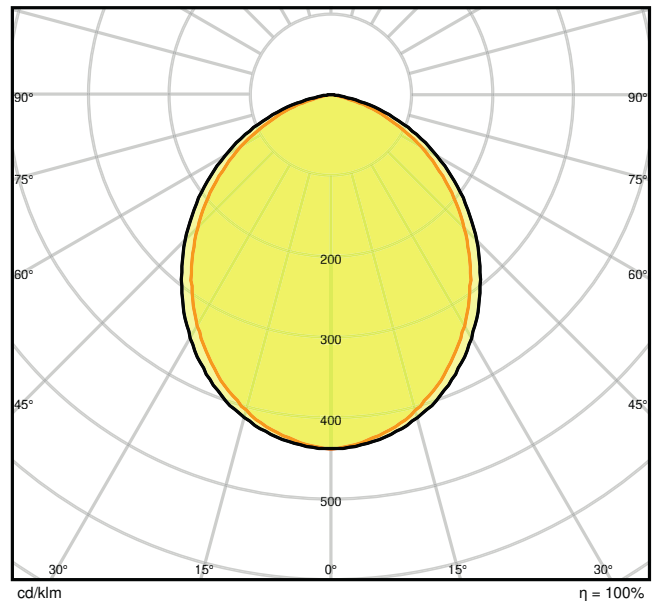

LDC typ polar

Dimensions & Weight

Diameter	160.00 mm
Height	52.00 mm
Product weight	360.00 g

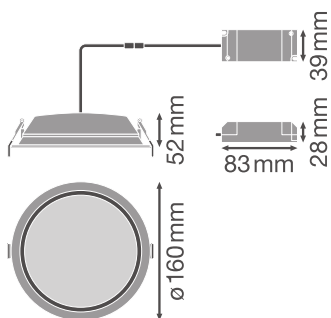

Materials & Colors

Product color	White
---------------	-------



Housing color	White
Body material	Aluminum
Cover material	Polymethylmethacrylate (PMMA)
Glow Wire Test according to IEC 60695-2-12	650 °C
Mercury content	0.0 mg

Application & Mounting

Ambient temperature range	-20...+45 °C
Temperature range at storage	-20...+80 °C
Type of connection	Screwless terminal, 2-Pole
Type of protection	IP44/IP20
Protection class IK (shock resistance)	IK02
Dimmable	No
Mounting type	Recessed
Mounting location	Ceiling
Application environment	Indoor
Mounting diameter	150 mm
Mounting depth	100 mm
LED module replaceable	Not replaceable
With light source	Yes

Lifespan

Lifespan L70/B50 at 25 °C	50000 h
Lifespan L80/B10 at 25 °C	45000 h
Lifespan L90/B10 at 25 °C	30000 h
Number of switching cycles	100000

Control gear













Output current	27...42 mA
ECG - Output ripple current	< 45 %
ECG - Length	83 mm
ECG - Width	39 mm
ECG - Height	28 mm

Certificates & Standards

Standards	CE / CB / ENEC / TÜV SÜD
-----------	--------------------------

Luminaire with limited surface temperature, "D sign"	No
Ball shot safe	No

DOWNLOAD DATA

DOWNLOAD DATA	
	User instruction
	Addon Technical Information
	Tender documents
	Declarations of conformity
	Declarations of conformity
	On-Pack-Info
	IES file (IES)
	LDT file (Eulumdat)
	R3D file (Relux 3D Model)
	M3D file (3D Model)
	ULD file (DIALux)
	UGR file (UGR table)

LOGISTICAL DATA

Product code	Packaging unit (Pieces/Unit)	Dimensions (length x width x height)	Gross weight	Volume
4058075091443	Shipping box 8	365 mm x 365 mm x 185 mm	4105.00 g	24.65 dm ³

The mentioned product code describes the smallest quantity unit which can be ordered. One shipping unit can contain one or more single products. When placing an order, for the quantity please enter single or multiples of a shipping unit.



ADDITIONAL CATALOG INFORMATION

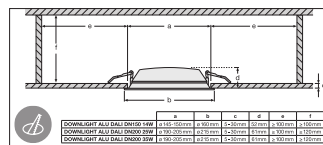
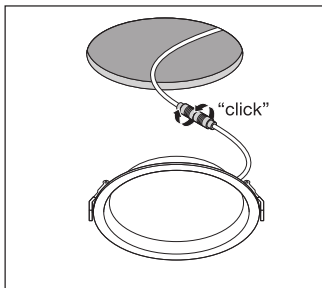
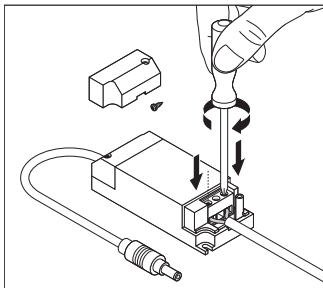

References / Links

- For Guarantee see www.ledvance.com/guarantee

DISCLAIMER

Subject to change without notice. Errors and omission excepted. Always make sure to use the most recent release.

