

Features

- High Efficiency (Up to 93%)
- Full Power at Wide Output Current Range (Constant Power)
- Adjustable Output Current (AOC) with Dip-switch
- Non-dimming Control
- Input Surge Protection: 6kV line-line, 10kV line-earth
- All-Around Protection: OVP, SCP, OTP
- Waterproof (IP67)
- SELV Output
- Suitable for Independent Use
- 5 Years Warranty



Description

The EUP-096SxxxSV series is a 96W, constant-current, AOC LED driver that operates from 90-305 Vac input with excellent power factor. It is created for many lighting applications including street, tunnel and bay. The high efficiency of these drivers and compact metal case enables them to run cooler, significantly improving reliability and extending product life. To ensure trouble-free operation, protection is provided against input surge, output over voltage, short circuit, and over temperature.

Models

Adjustable Output Current Range	Full-Power Current Range (1)	Default Output Current	Input Voltage Range(2)	Output Voltage Range	Max. Output Power	Typical Efficiency (3)	Power Factor		Model Number
							120Vac	220Vac	
350-700mA	450-700mA	550 mA	90~305 Vac/ 127~250 Vdc	74~213Vdc	96 W	93.0%	0.99	0.96	EUP-096S070SV
700-1050mA	700-1050mA	700 mA	90~305 Vac/ 127~250 Vdc	48~137Vdc	96 W	93.0%	0.99	0.96	EUP-096S105SV
850-1500mA	1050-1500mA	1050 mA	90~305 Vac/ 127~300 Vdc	32~91Vdc	96 W	92.5%	0.99	0.96	EUP-096S150SV ⁽⁴⁾
1000-2100mA	1400-2100mA	2100 mA	90~305 Vac/ 127~250 Vdc	24 ~ 69Vdc	96 W	92.0%	0.99	0.96	EUP-096S210SV ⁽⁴⁾
2100-3500mA	2625-3500mA	2800 mA	90~305 Vac/ 127~250 Vdc	14 ~ 36Vdc	96 W	91.5%	0.99	0.96	EUP-096S350SV ⁽⁴⁾

- Notes:** (1) Output current range with constant power at 96W
 (2) Certified voltage range: 100-240Vac or 127-250Vdc (except CCC, PSE, KS and BIS)
 (3) Measured at 100% load and 220Vac input (see below "General Specifications" for details).
 (4) SELV Output.

Input Specifications

Parameter	Min.	Typ.	Max.	Notes
Input Voltage	90 Vac	-	305 Vac	127~250 Vdc
Input Frequency	47 Hz	-	63 Hz	
Leakage Current	-	-	0.70 mA	IEC60598-1; 240Vac/ 60Hz,
Input AC Current	-	-	1.10 A	Measured at 100% load and 120 Vac input.
	-	-	0.65 A	Measured at 100% load and 220 Vac input.

Input Specifications (Continued)

Parameter	Min.	Typ.	Max.	Notes
Inrush Current(I ² t)	-	-	1.30 A ² s	At 220Vac input, 25°C cold start, duration=640μs, 10%Ipk-10%Ipk. See Inrush Current Waveform for the details.
PF	0.9	-	-	At 100-240Vac, 50-60Hz, 60%-100% Load (58-96W)
THD	-	-	20%	
THD	-	-	10%	At 220-240Vac, 50-60Hz, 75%-100% Load (72-96W)

Output Specifications

Parameter	Min.	Typ.	Max.	Notes
Output Current Tolerance	-5%loset	-	5%loset	100% load
Output Current Setting(loset) Range				
EUP-096S070SV	350 mA	-	700 mA	
EUP-096S105SV	700 mA	-	1050 mA	
EUP-096S150SV	850 mA	-	1500 mA	
EUP-096S210SV	1000 mA	-	2100 mA	
EUP-096S350SV	2100 mA	-	3500 mA	
Output Current Setting Range with Constant Power				
EUP-096S070SV	450 mA	-	700 mA	
EUP-096S105SV	700 mA	-	1050 mA	
EUP-096S150SV	1050 mA	-	1500 mA	
EUP-096S210SV	1400 mA	-	2100 mA	
EUP-096S350SV	2625 mA	-	3500 mA	
Total Output Current Ripple (pk-pk)	-	5%lomax	10%lomax	100% load. 20 MHz BW
Startup Overshoot Current	-	-	10%lomax	100% load
No Load Output Voltage				
EUP-096S070SV	-	-	250 V	
EUP-096S105SV	-	-	160 V	
EUP-096S150SV	-	-	110 V	
EUP-096S210SV	-	-	85 V	
EUP-096S350SV	-	-	42 V	
Line Regulation	-	-	±0.5%	100% load
Load Regulation	-	-	±1.5%	
Turn-on Delay Time	-	-	1.0 s	Measured at 120Vac input, 60%-100% Load
	-	-	0.5 s	Measured at 220Vac input, 60%-100% Load
Temperature Coefficient of loset	-	0.03%/°C	-	Case temperature = 0°C ~Tc max

Note: All specifications are typical at 25°C unless otherwise stated.

General Specifications

Parameter	Min.	Typ.	Max.	Notes			
Efficiency at 120 Vac input: EUP-096S070SV Io= 450 mA Io= 700 mA EUP-096S105SV Io= 700 mA Io=1050 mA EUP-096S150SV Io=1050 mA Io=1500 mA EUP-096S210SV Io=1400 mA Io=2100 mA EUP-096S350SV Io=2625 mA Io=3500 mA	88.5% 87.5% 88.5% 87.0% 88.0% 86.5% 87.5% 86.5% 87.5% 86.0%	90.5% 89.5% 90.5% 89.0% 90.0% 88.5% 89.5% 88.5% 89.5% 88.0%	- - - - - - - - - -	Measured at 100% load and steady-state temperature in 25°C ambient; (Efficiency will be about 2.0% lower if measured immediately after startup.)			
Efficiency at 220 Vac input: EUP-096S070SV Io= 450 mA Io= 700 mA EUP-096S105SV Io= 700 mA Io=1050 mA EUP-096S150SV Io=1050 mA Io=1500 mA EUP-096S210SV Io=1400 mA Io=2100 mA EUP-096S350SV Io=2625 mA Io=3500 mA	91.0% 89.5% 91.0% 89.5% 90.5% 89.0% 90.0% 89.0% 89.5% 88.5%	93.0% 91.5% 93.0% 91.5% 92.5% 91.0% 92.0% 91.0% 91.5% 90.5%	- - - - - - - - - -		Measured at 100% load and steady-state temperature in 25°C ambient; (Efficiency will be about 2.0% lower if measured immediately after startup.)		
Efficiency at 277 Vac input: EUP-096S070SV Io= 450 mA Io= 700 mA EUP-096S105SV Io= 700 mA Io=1050 mA EUP-096S150SV Io=1050 mA Io=1500 mA EUP-096S210SV Io=1400 mA Io=2100 mA EUP-096S350SV Io=2625 mA Io=3500mA	91.0% 90.0% 91.5% 90.0% 90.5% 89.0% 90.0% 89.0% 90.0% 89.0%	93.0% 92.0% 93.5% 92.0% 92.5% 91.0% 92.0% 91.0% 92.0% 91.0%	- - - - - - - - - -			Measured at 100% load and steady-state temperature in 25°C ambient; (Efficiency will be about 2.0% lower if measured immediately after startup.)	
MTBF	-	355,000 Hours	-				Measured at 220Vac input, 80%Load and 25°C ambient temperature (MIL-HDBK-217F)
Lifetime	-	77,000 Hours	-				Measured at 220Vac input, 80%Load and 70°C case temperature; See lifetime vs. Tc curve for the details
Operating Case Temperature for Safety Tc_s	-40°C	-	+90°C				
Operating Case Temperature for Warranty Tc_w	-40°C	-	+75°C				Case temperature for 5 years warranty

General Specifications (Continued)

Parameter	Min.	Typ.	Max.	Notes
Storage Temperature	-40°C	-	+85°C	Humidity: 5%RH to 100%RH
Dimensions Inches (L × W × H) Millimeters (L × W × H)	6.34 × 2.37 × 1.44 161 × 60 × 36.5			With mounting ear 7.17 × 2.37 × 1.44 182 × 60 × 36.5
Net Weight	-	750 g	-	

Note: All specifications are typical at 25°C unless otherwise stated.

Safety & EMC Compliance

Safety Category	Standard
CE	EN 61347-1, EN61347-2-13
CCC	GB 19510.1, GB 19510.14
KS	KS C 7655
EMI Standards	Notes
EN 55015/GB 17743 ⁽¹⁾	Conducted emission Test & Radiated emission Test
EN 61000-3-2/GB 17625.1	Harmonic current emissions
EN 61000-3-3	Voltage fluctuations & flicker
EMS Standards	Notes
EN 61000-4-2	Electrostatic Discharge (ESD): 8 kV air discharge, 4 kV contact discharge
EN 61000-4-3	Radio-Frequency Electromagnetic Field Susceptibility Test-RS
EN 61000-4-4	Electrical Fast Transient / Burst-EFT
EN 61000-4-5	Surge Immunity Test: AC Power Line: line to line 6 kV, line to earth 10 kV ⁽²⁾
EN 61000-4-6	Conducted Radio Frequency Disturbances Test-CS
EN 61000-4-8	Power Frequency Magnetic Field Test
EN 61000-4-11	Voltage Dips
EN 61547	Electromagnetic Immunity Requirements Applies To Lighting Equipment

Note: (1) This LED driver meets the EMI specifications above, but EMI performance of a luminaire that contains it depends also on the other devices connected to the driver and on the fixture itself.

(2) To perform electric strength (hi-pot) testing, the “GDT ground disconnect” (nut and metal lock sheet) on the driver end-cap should be removed temporarily to prevent the internal gas discharge tube from conducting (as allowed by IEC 60598-1 Clause 10.2). After testing is completed, these items must be reinstalled to restore line-to-earth surge protection and secure the end cap.

Derating

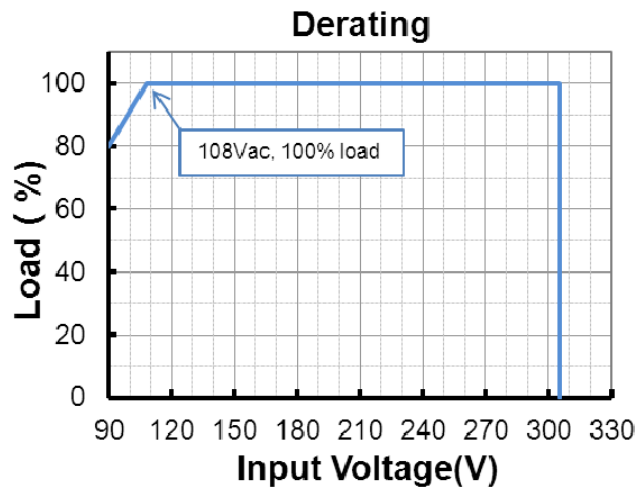

Lifetime vs. Case Temperature

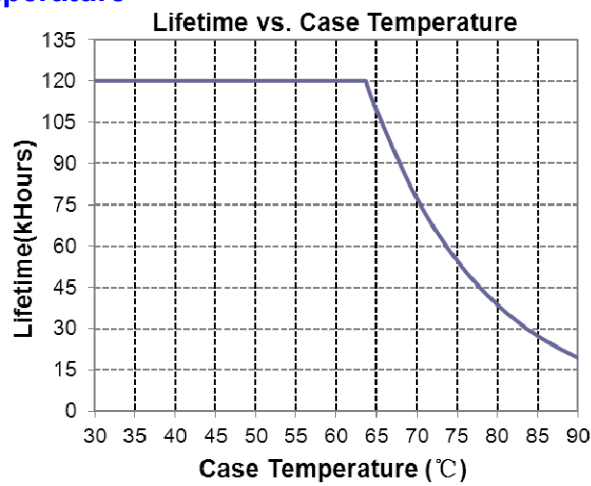

Inrush Current Waveform

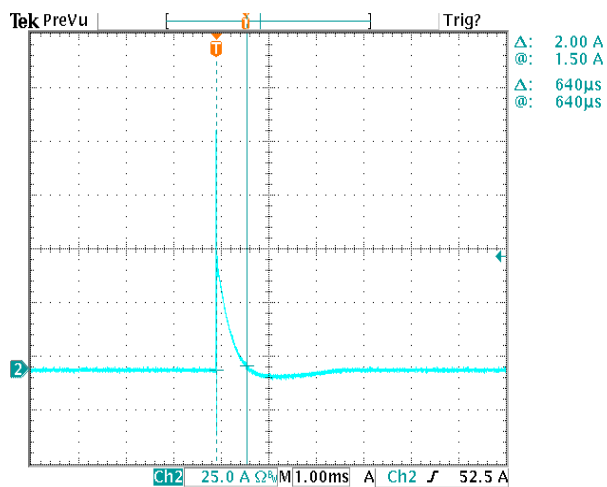

Efficiency vs. Load

EUP-096S070SV ($I_o=450mA$)
Efficiency vs. Output Voltage

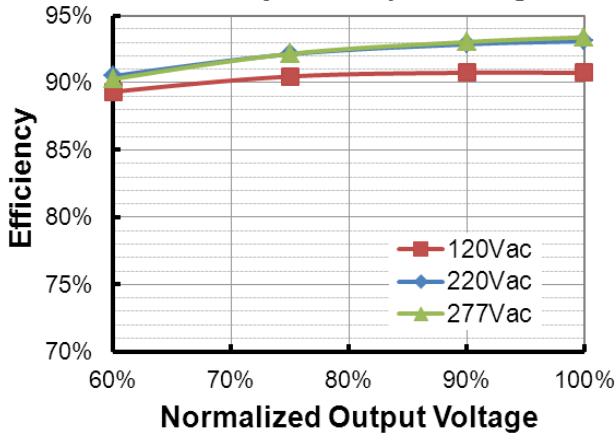

EUP-096S070SV ($I_o=700mA$)
Efficiency vs. Output Voltage

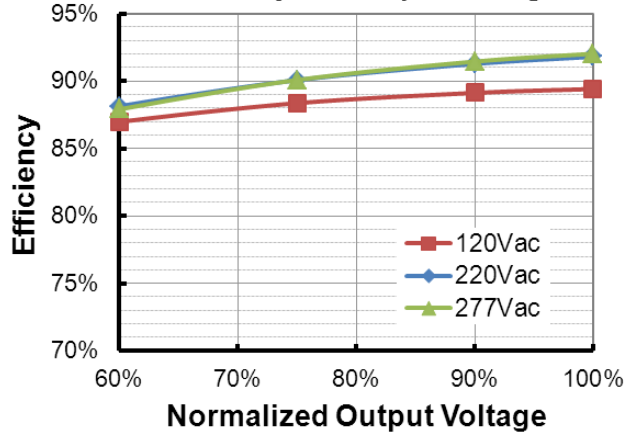

EUP-096S105SV ($I_o=700mA$)
Efficiency vs. Output Voltage

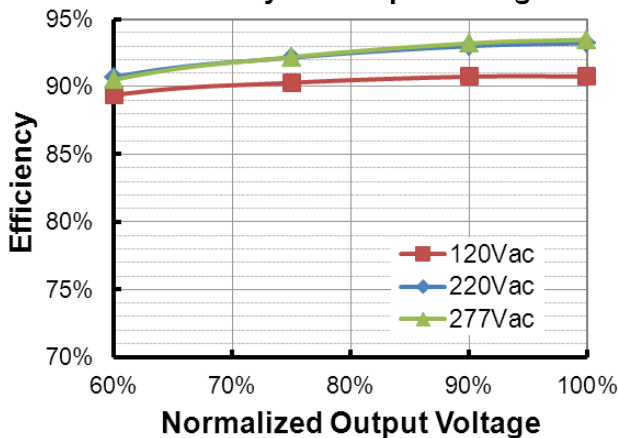

EUP-096S105SV ($I_o=1050mA$)
Efficiency vs. Output Voltage

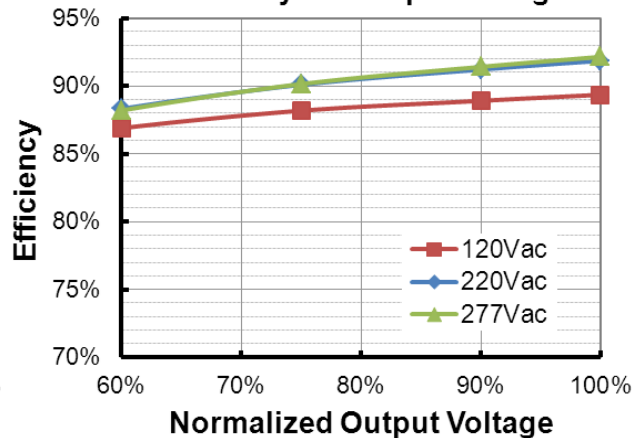

EUP-096S150SV ($I_o=1050mA$)
Efficiency vs. Output Voltage

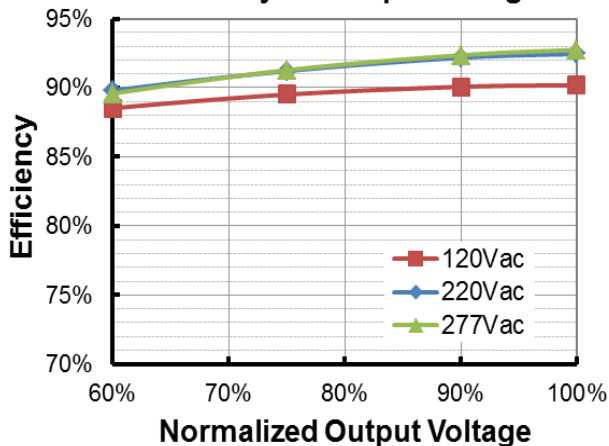

EUP-096S150SV ($I_o=1500mA$)
Efficiency vs. Output Voltage

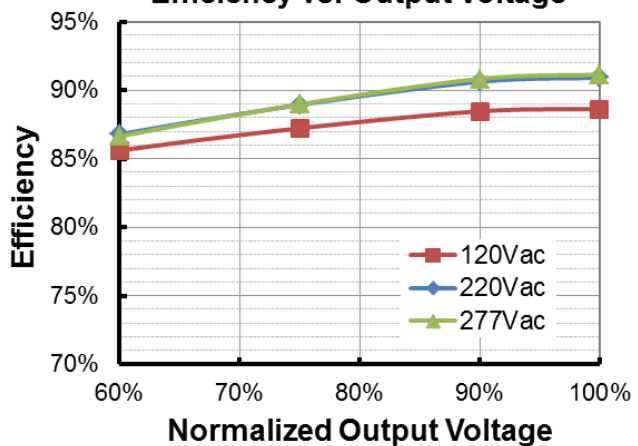

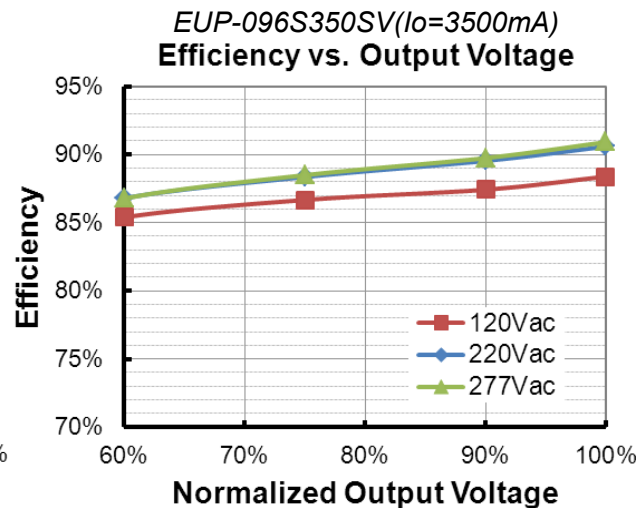
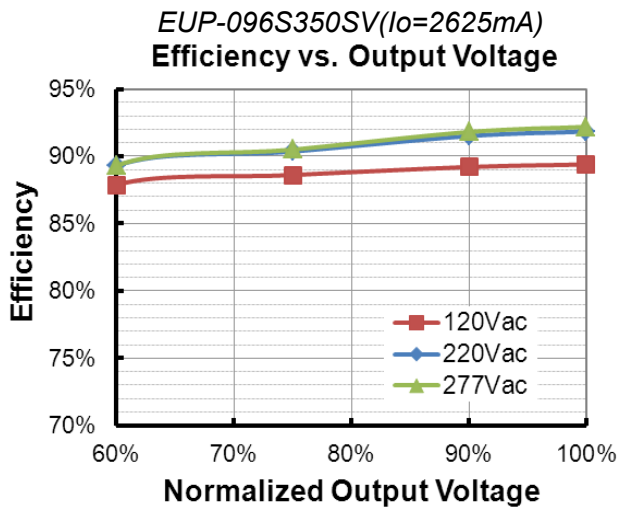
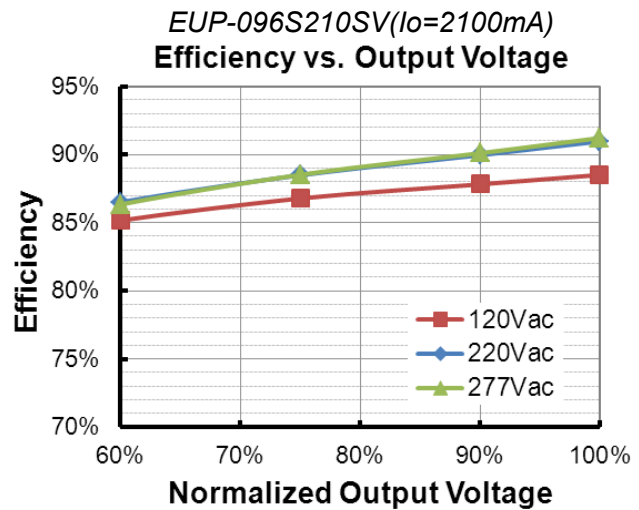
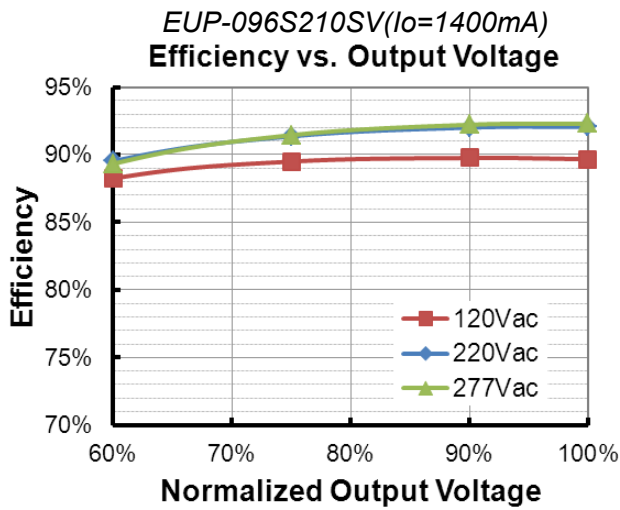

Power Factor

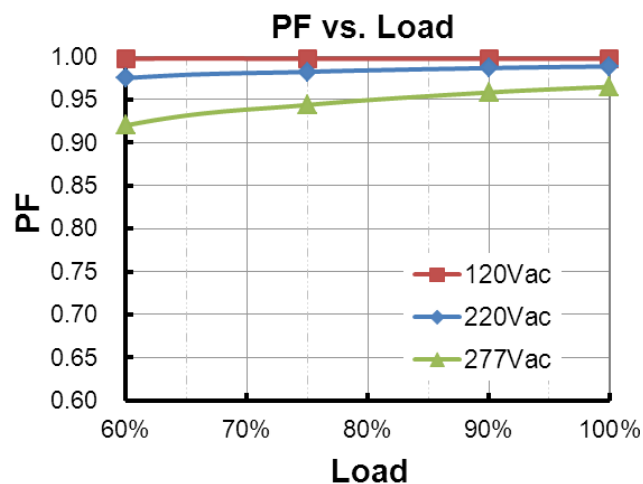

Total Harmonic Distortion

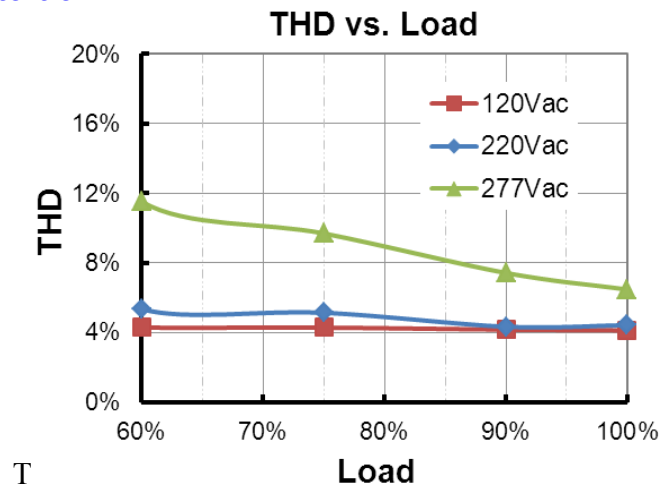

Protection Functions

Parameter	Notes
Over Temperature Protection	Decreases output current, returning to normal after over temperature is removed.
Short Circuit Protection	Auto Recovery. No damage will occur when any output is short circuited. The output shall return to normal when the fault condition is removed.
Over Voltage Protection	Limits output voltage at no load and in case the normal voltage limit fails.

Output Current vs. Dip Switch Setting

● EUP-096S070SV

Dip Switch Setting				Output Current Setting (loset)	Output Voltage Range		Notes
1	2	3	4	Typ.	Min.	Max.	/
OFF	ON	ON	ON	700mA	74V	137V	Output Current Setting with Constant Power.
OFF	ON	ON	OFF	650mA	74V	148V	
OFF	ON	OFF	ON	600mA	80V	160V	
OFF	ON	OFF	OFF	550mA	87V	174V	
OFF	OFF	ON	ON	500mA	96V	192V	
OFF	OFF	ON	OFF	450mA	107V	213V	
OFF	OFF	OFF	ON	400mA	120V	213V	Output Current Setting with Power Derating.
OFF	OFF	OFF	OFF	350mA	137V	213V	

● EUP-096S105SV

Dip Switch Setting				Output Current Setting (loset)	Output Voltage Range		Notes
1	2	3	4	Typ.	Min.	Max.	/
ON	ON	ON	ON	1050mA	48V	91V	Output Current Setting with Constant Power.
ON	ON	ON	OFF	1000mA	48V	96V	
ON	ON	OFF	ON	950mA	51V	101V	
ON	ON	OFF	OFF	900mA	53V	106V	
ON	OFF	ON	ON	850mA	57V	113V	
ON	OFF	ON	OFF	800mA	60V	120V	
ON	OFF	OFF	ON	750mA	64V	128V	
ON	OFF	OFF	OFF	700mA	69V	137V	

● EUP-096S150SV

Dip Switch Setting				Output Current Setting (loset)	Output Voltage Range		Notes
1	2	3	4	Typ.	Min.	Max.	/
ON	ON	ON	ON	1500mA	32V	64V	Output Current Setting with Constant Power.
ON	ON	ON	OFF	1450mA	33V	66V	
ON	ON	OFF	ON	1400mA	35V	68.5V	
ON	ON	OFF	OFF	1350mA	36V	71V	
ON	OFF	ON	ON	1300mA	37V	74V	
ON	OFF	ON	OFF	1250mA	39V	77V	
ON	OFF	OFF	ON	1200mA	40V	80V	
ON	OFF	OFF	OFF	1150mA	42V	83.5V	
OFF	ON	ON	ON	1100mA	44V	87V	
OFF	ON	ON	OFF	1050mA	46V	91V	
OFF	ON	OFF	ON	1000mA	48V	91V	Output Current Setting with Power Derating.
OFF	ON	OFF	OFF	950mA	51V	91V	
OFF	OFF	ON	ON	900mA	54V	91V	
OFF	OFF	ON	OFF	850mA	57V	91V	

● EUP-096S210SV

Dip Switch Setting				Output Current Setting (I _o set)	Output Voltage Range		Notes
1	2	3	4	Typ.	Min.	Max.	/
ON	ON	ON	ON	2100mA	24V	45.5V	Output Current Setting with Constant Power.
ON	ON	ON	OFF	2000mA	24V	48V	
ON	ON	OFF	ON	1900mA	26V	50.5V	
ON	ON	OFF	OFF	1800mA	27V	53V	
ON	OFF	ON	ON	1700mA	29V	56.5V	
ON	OFF	ON	OFF	1600mA	30V	60V	
ON	OFF	OFF	ON	1500mA	32V	64V	
ON	OFF	OFF	OFF	1400mA	35V	69V	
OFF	ON	ON	ON	1300mA	37V	69V	
OFF	ON	ON	OFF	1200mA	40V	69V	
OFF	ON	OFF	ON	1100mA	44V	69V	
OFF	ON	OFF	OFF	1000mA	48V	69V	

● EUP-096S350SV

Dip Switch Setting				Output Current Setting (I _o set)	Output Voltage Range		Notes
1	2	3	4	Typ.	Min.	Max.	/
ON	ON	ON	ON	3500mA	14V	27.5V	Output Current Setting with Constant Power.
ON	ON	ON	OFF	3325mA	15V	28.5V	
ON	ON	OFF	ON	3150mA	16V	30.5V	
ON	ON	OFF	OFF	2975mA	16V	32V	
ON	OFF	ON	ON	2800mA	17V	34V	
ON	OFF	ON	OFF	2625mA	18V	36V	
ON	OFF	OFF	ON	2450mA	20V	36V	
ON	OFF	OFF	OFF	2275mA	21V	36V	
OFF	ON	ON	ON	2100mA	23V	36V	

Notes:

1. Dip switch must be set in the setting range as specified to insure the driver operates as expected.
2. Endcap covering dip switch must be tight to insure IP67 rating.

Mechanical Outline

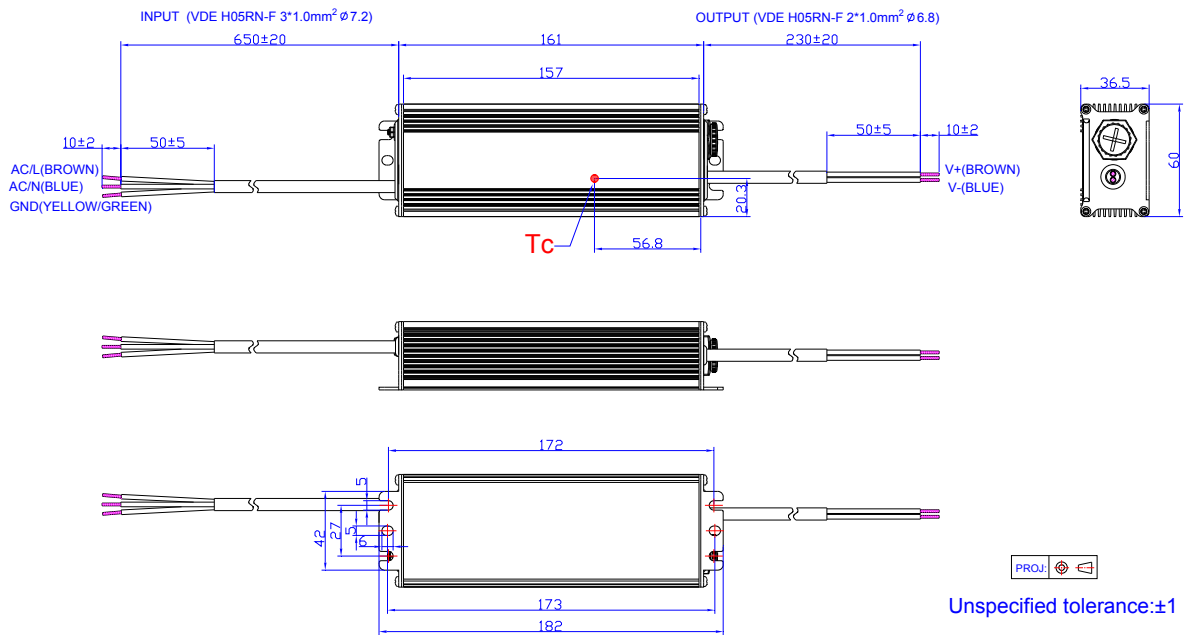

RoHS Compliance

Our products comply with the European Directive 2011/65/EC, calling for the elimination of lead and other hazardous substances from electronic products.

Revision History

Change Date	Rev.	Description of Change		
		Item	From	To
2016-08-09	A	Datasheets Release	/	/
2017-11-29	B	Features	/	Updated
		Models	EUP-096S150SV	Added
		Input Specifications	PF/THD	Updated
		Output Current Setting(losset) Range	EUP-096S150SV	Added
		Output Current Setting Range with Constant Power	EUP-096S150SV	Added
		No Load Output Voltage	EUP-096S150SV	Added
		Temperature Coefficient of losset	Max 0.03%/°C	Typ 0.03%/°C
		Efficiency at 120 Vac input	EUP-096S150SV	Added
		Efficiency at 220 Vac input	EUP-096S150SV	Added
		Efficiency at 277 Vac input	EUP-096S150SV	Added
		General Specifications	Operating Case Temperature for Warranty Tc_w	Updated
		Safety &EMC Compliance	/	Updated
		Efficiency vs. Load	EUP-096S150SV	Added
Output Current vs. Dip Switch Setting	EUP-096S150SV	Added		
2018-04-20	C	Description	/	Updated
		Mechanical Outline	/	Updated
2018-07-16	D	EAC	/	Added