

DALI RGB LED Dimmer CC

Datasheet Control Gear



RGB LED Dimmer (CC, DT8)

common plus connector:

Art. Nr. 86458913-350 (350mA)

Art. Nr. 86458913-500 (500mA)

Art. Nr. 86458913-700 (700mA)

common minus connector:

Art. Nr. 86458913-350GM (350mA)

Art. Nr. 86458913-500GM (500mA)

Art. Nr. 86458913-700GM (700mA)

DALI RGB LED Dimmer CC Control Gear

Overview

- DALI LED-Dimmer for RGB colour control
- Suitable for constant current LED-modules
- **Operating Mode DT8:** one DALI-address for the independent control of level and colour (DALI DT8, Type RGBWAF)
- **Operating Mode Colour&Dim:** control by 2 DALI-addresses, one for adjusting the level and one for adjusting the colour
- **SwitchDim2:** 2 switch-inputs offer control of level and colour without DALI
- dimming range 0.1%-100%
- adjustable PWM-frequency (122Hz/244Hz/488Hz/976Hz)
- types for constant currents of 350mA, 500mA and 700mA
- types with common plus and common minus connector available
- suitable for integration in luminaires or remote ceiling
- supply voltage 12V to 48V DC
- output voltage up to 45VDC
- integrated short circuit protection
- low standby power consumption
- high efficiency
- configuration via PC-software DALI-Cockpit and DALI USB-interface
- user-friendly factory default settings

Specification, Characteristics

common plus connector:

type	DALI RGB 350mA GP	DALI RGB 500mA GP	DALI RGB 700mA GP
article number	86458913-350	86458913-500	86458913-700

electrical data:			
supply voltage V_{in}	12VDC-48VDC		
max. input current I_{inmax}	350mA	500mA	700mA
max. output current I_{led}	350mA	500mA	700mA
output voltage range V_{led}	3V-45V (at 48V supply)		
control input	DALI SwitchDim2 (mains voltage)		
current consumption DALI	2mA		
number of DALI-addresses	operating mode DT8: 1 operating mode Colour&Dim: 2		
standby power consumption (12V)	~ 180mW		

technical data:	
power on behaviour	configurable via DALI: 0%-100% or last value
ambient temperature	-20°C to +60°C
expected lifetime	>100000h (at $T_c \leq 75^\circ C$)

protection class	IP20
max. connecting wire cross section	up to 1.5 mm ² , supply (V+, V-): up to 2.5 mm ²
dimensions (LxWxH)	120mmx30mmx22mm
housing/mounting	remote ceiling

on request: output currents from 100mA to 700mA available

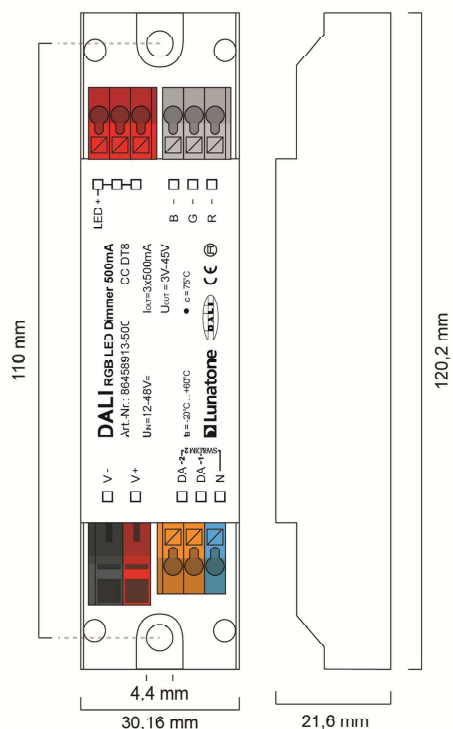

dimensions common plus connector type



connection plan common plus connector type

common minus connector:

type	DALI RGB 350mA GM	DALI RGB 500mA GM	DALI RGB 700mA GM
article number	86458913-350GM	86458913-500GM	86458913-700GM

electrical data:			
supply voltage V_{in}	12VDC-48VDC		
max. input current I_{inmax}	350mA	500mA	700mA
max. output current I_{led}	350mA	500mA	700mA
output voltage range V_{led}	3V-45V (at 48V supply)		
control input	DALI SwitchDim2 (mains voltage)		
current consumption DALI	2mA		
number of DALI-addresses	operating mode DT8: 1 operating mode Colour&Dim: 2		
standby power consumption (12V)	~ 180mW		

technical data:	
power on behaviour	configurable via DALI: 0%-100% or last value
ambient temperature	-20°C to +60°C

expected lifetime	>100000h (at Tc<=75°C)
protection class	IP20
max. connecting wire cross section	up to 1.5 mm ² , supply (V+, V-): up to 2.5 mm ²
dimensions (LxWxH)	120mmx30mmx22mm
housing/mounting	remote ceiling

on request: output currents from 100mA to 700mA available

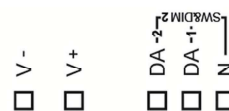
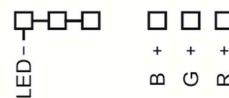
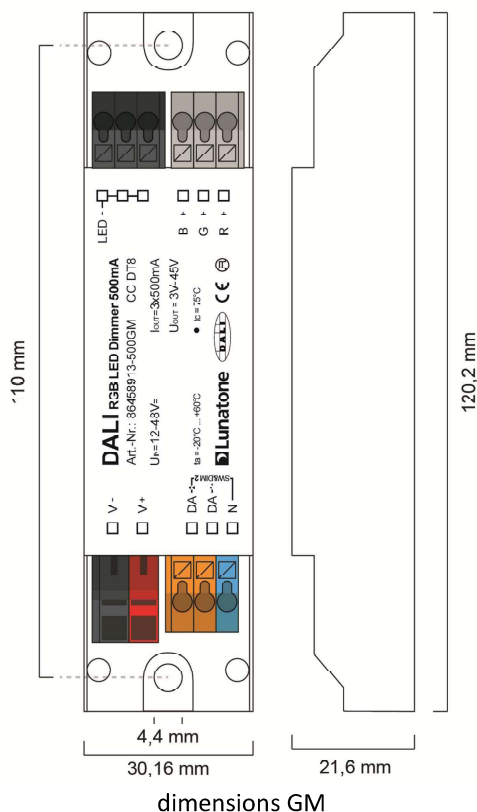

connection plan GM



Hint:
For highest efficiency the input voltage should range between 3V and 10V above the LED-voltage:

- 4-6 LEDs: 24V
- 6-9LEDs: 36V
- 10-12 LEDs: 48V

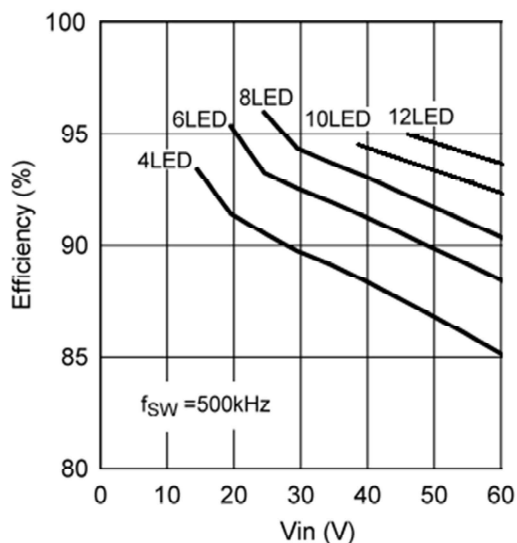

DALI (common plus connector type):

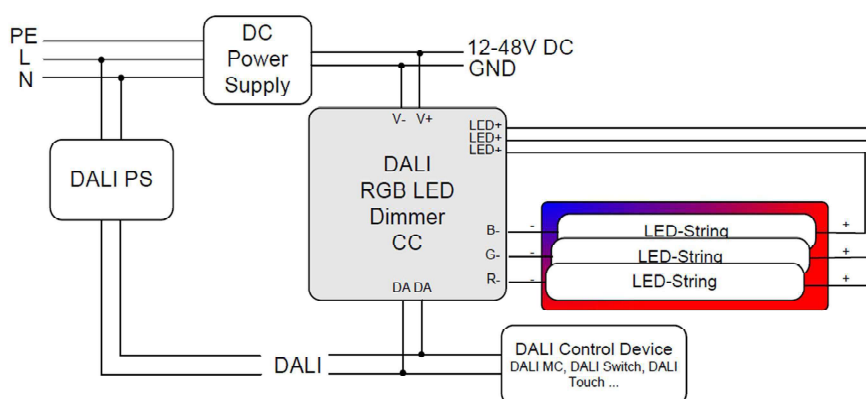

SwitchDim2 (common plus connector type):

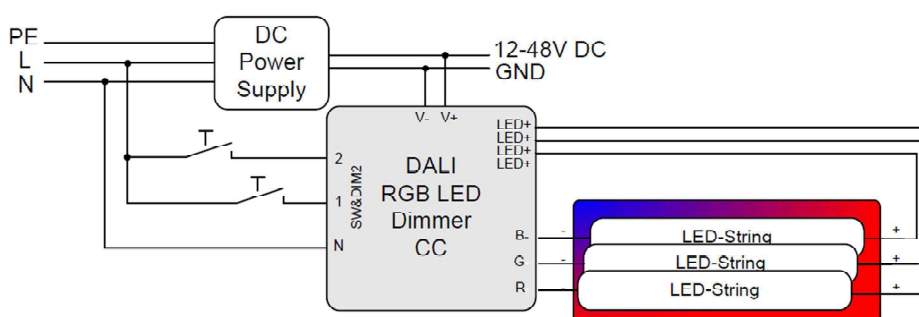

Operating Modes

The device offers several operating modes:

DT8 (factory default)

In this operating mode one DALI-address for the independent control of light level and colour is used (Device Type 8 RGBWAF).

Alternatively the device can be controlled using 2 switch-inputs for mains voltage (SwitchDim2):

SwD1: light level

- short press: On/Off
- long press: dimming

SwD2: colour

- long press: change colour

Colour&Dim

This operating mode is suitable for operating RGB—luminaires. Two DALI-addresses are

used, the first to control the light level and the second for changing the distribution on the output channels (e.g. for colour adjustments).

The Colour&Dim mode allows colour adjustments without affecting the level and vice versa. For each channel only DALI-standard commands like dim up/down but also DAP are used. Thus the device can be used with all common controls and gateways (e.g. KNX). The Colour&Dim mode provides an alternative to the DT8-RGBWAF mode.

Can be operated via DALI or SwitchDim2:

DALI-address 1, SwD1: light level

DALI-address 2, SwD2: colour

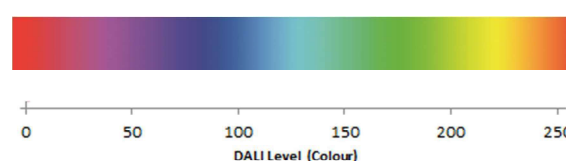

Selection of operating mode

With the help of the PC-software tool DALI-Cockpit the operating mode can be easily set on the general settings page.

Operating mode DT8-RGBWAF:

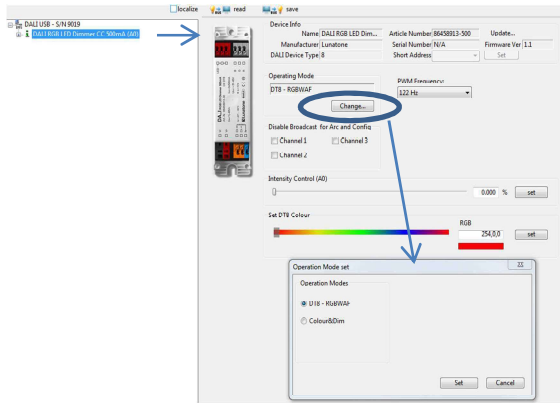

In addition, on the same page the PWM-frequency can be selected and basic control elements for testing each operating modes are available (slider for level and colour in the operating modes DT8 and Colour&Dim). Furthermore the broadcast control can be deactivated for each channel individually.

Operating mode Colour&Dim:

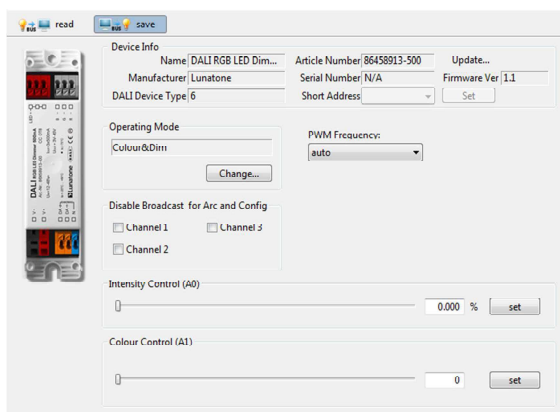

Switching between operating modes can also be done with the help of the DALI-command SET OPERATING MODE (IEC 62386-102 Ed.2). When changing the operating mode the number of used DALI-addresses can change as well and this requires a new addressing procedure. In the DALI-Cockpit this address assignment is performed automatically.

Operating Mode:

number	operating mode
0x0	DT8 (factory default)
0x92	DT8
0x93	Colour&Dim

Additional Settings

Besides the settings on the general page each channel can be selected separately in the component tree for individual configuration.

Component Tree:

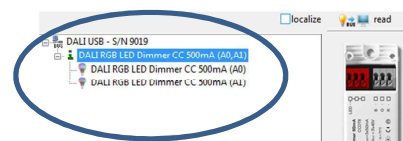

Settings in the operating mode DT8-RGBWAF (displayed parameters are the factory default values):

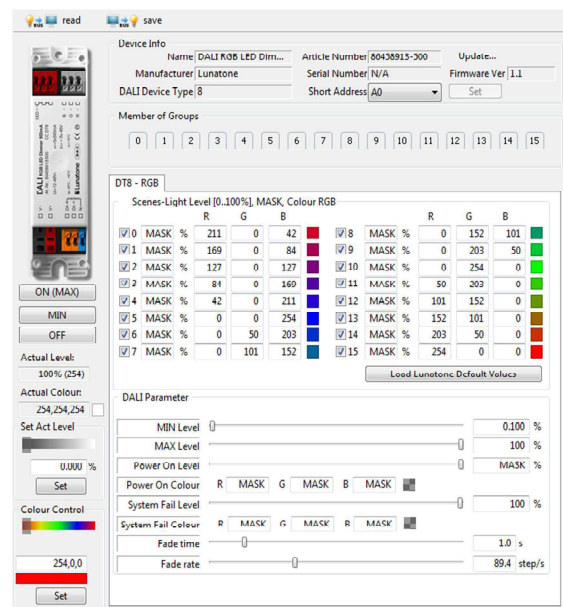

Settings for each channel in the operating mode Colour&Dim:

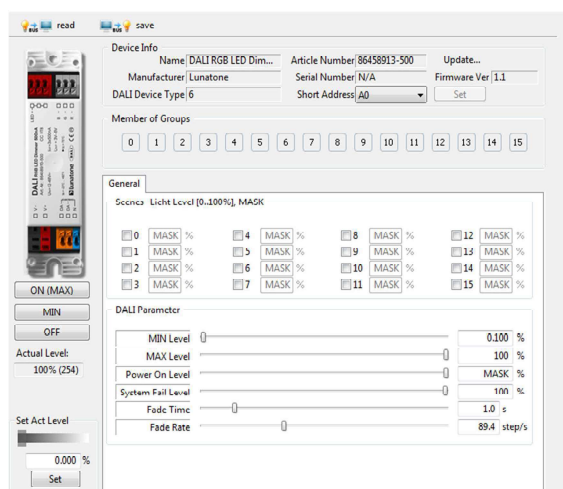

For each address the group membership can be set as well as scene values and DALI-parameters. In Colour&Dim operating mode, all values assigned to channel 2 are representing colours.

Factory Default Settings

Before the initial addressing is performed, the device can already be controlled by a group address.

Summary of the factory default settings (delivery state):

Operating mode	DT8
SwitchDim2	SwD1: level SwD2: colour
Min Level	0.1%
PowerOn Level	MASK (letzter Wert)
Fade Time	2 (1s)
Fade Rate	5 (89.4 steps/s)
PWM-frequency	auto
Groups before initial addressing:	G0 (or G0 and G1 in operating mode Colour&Dim)

Predefined Scene Values:

			R	G	B	
<input checked="" type="checkbox"/>	0	MASK	%	211	0	42
<input checked="" type="checkbox"/>	1	MASK	%	169	0	84
<input checked="" type="checkbox"/>	2	MASK	%	127	0	127
<input checked="" type="checkbox"/>	3	MASK	%	84	0	169
<input checked="" type="checkbox"/>	4	MASK	%	42	0	211
<input checked="" type="checkbox"/>	5	MASK	%	0	0	254
<input checked="" type="checkbox"/>	6	MASK	%	0	50	203
<input checked="" type="checkbox"/>	7	MASK	%	0	101	152
<input checked="" type="checkbox"/>	8	MASK	%	0	152	101
<input checked="" type="checkbox"/>	9	MASK	%	0	203	50
<input checked="" type="checkbox"/>	10	MASK	%	0	254	0
<input checked="" type="checkbox"/>	11	MASK	%	50	203	0
<input checked="" type="checkbox"/>	12	MASK	%	101	152	0
<input checked="" type="checkbox"/>	13	MASK	%	152	101	0
<input checked="" type="checkbox"/>	14	MASK	%	203	50	0
<input checked="" type="checkbox"/>	15	MASK	%	254	0	0

Purchase Order Information

Art.Nr. 86458913-xxx: DALI RGB LED Dimmer, CC constant current xxx mA (100mA-700mA), **common plus connector**, supply 12V-48V DC, output voltage 3V-45V DC, **SwitchDim2**, remote ceiling & integration in luminaires

Art.Nr. 86458913-xxxGM: DALI RGB LED Dimmer, CC – constant current xxx mA (100mA-700mA), **common minus connector**, supply 12V-48V DC, output voltage 3V-45V DC, **SwitchDim2**, remote ceiling & integration in luminaires

Additional Information and Equipment

DALI-Cockpit – free configuration tool from Lunatone for DALI systems
<http://lunatone.at/en/downloads/Lunatone-DALI-Cockpit.zip>

Lunatone DALI products
<http://www.lunatone.at/en/>

Lunatone datasheets and manuals
<http://lunatone.at/en/downloads/>

Contact

Technical Support: support@lunatone.com

Requests: sales@lunatone.com

www.lunatone.com

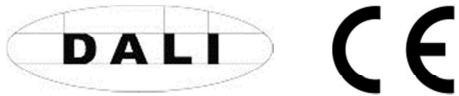

Disclaimer

Subject to change. Information provided without guarantee.
The datasheet refers to the current delivery.

The compatibility with other devices must be tested in advance
to the installation.