



## DALI RM8 PWM DALI RM8 1-10V DALI RM16 1-10V

### Datenblatt

Interface for DALI to 10V PWM with  
SPST-relay

Converter module for the integration  
of 0-10V or 1-10V controlled ballasts  
in DALI lighting systems (DT5)



Art. 86458668 (RM8 PWM)  
Art. 86458668-AN (RM8 1-10V)  
Art. 86458936 (RM16 1-10V PWM)  
Art. 86458667-DE (RM16 0-10V PWM)

# DALI RMx PWM/1-10V Interface

## Überblick

- For the integration of electronic ballasts with PWM input or 0-10V input
- An SPST-relay offers the possibility to power on/off the mains supply of the electronic ballast
- Types with PWM output offer the high noise immunity of digital signal transmission, suitable for electronic ballasts with PWM control input (e.g.: Meanwell HLG, HLN, NPF or LPF series)
- The type with analog output offers an automatic calibration algorithm for the output signal.
- Transformation of DALI 8-bit direct arc power level into PWM output signal (0-100%) or analog voltage (1-10V)
- DALI DT5 compatible: linear and logarithmic control characteristic
- DALI DT5: change of output range for PWM-type (0-100% / 10-100% PWM)
- Suitable for multiple ballast (max. sinking current 2mA)
- RM16 type for high inrush currents up to 160A
- The control of the SPST-relay is directly linked to the 8-bit direct arc power level. If the value is 0 the relay is OFF. At any other value the relay is ON.
- The module is supplied directly by the DALI signal line. An additional supply is not needed.
- The interface can be addressed and assigned to groups and scenes.
- galvanic isolation between DALI input and PWM or 1-10V output

## Specification, Characteristics

type	DALI RM8 1-10V	DALI RM8 1-10V	DALI RM16 1-10V	DALI RM16 0-10V PWM-DE
article number	86458668	86458668-AN	86458936	86458667-DE
<b>technical data:</b>				
supply	via DALI signal line			
typ. current consumption DALI-line	3 mA	4.2 mA	3 mA	3 mA
input	DALI			
output (0-10V)	0-100% PWM (14Bit, 488Hz), current sink 2mA	1-10V analog, current sink 1mA	0-100% PWM (14Bit, 488Hz), current sink 2mA	0-100% PWM (14Bit, 488Hz), current sink 2mA
relay output switch on/off voltage	250Vac/400Vac			
max. nominal load relay	1000VA	1000VA	2000VA	2000VA
max. switching current relay	8A	8A	16A	16A
max. inrush current relay	80A	80A	160A	160A

type of relay contact	1 On/Off		
relay: number of switching operations at 16A/250Vac, resistive	3x10 <sup>4</sup>		
maximum switching frequency	1 Hz		

**technical data:**

ambient temperature	0°C-45°C		
protection class	IP20		
connecting wire cross section	0,5-1,5 mm <sup>2</sup>	0,5-1,5 mm <sup>2</sup>	connector
mounting	back box	back box	remote ceiling

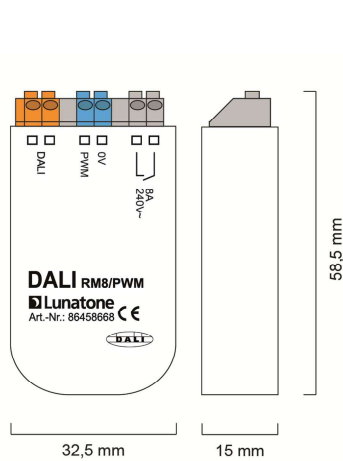

geometry RM8 PWM  
geometry RM8 1-10V

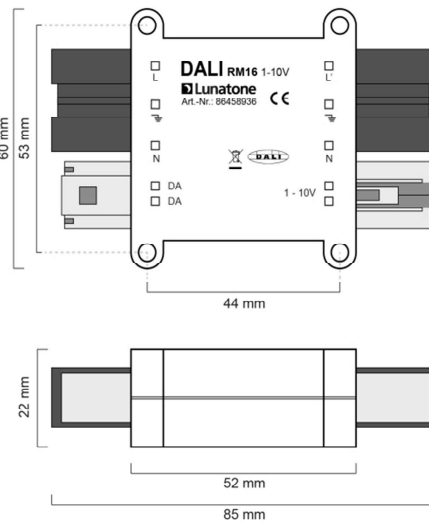

geometry RM16 1-10V

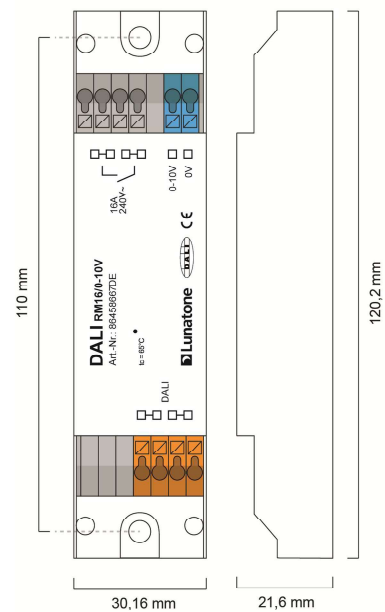

geometry RM16 0-10V DE

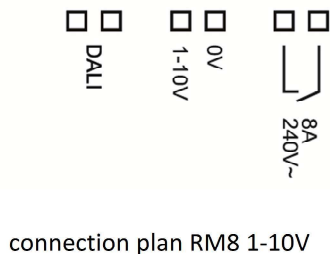

connection plan RM8 1-10V

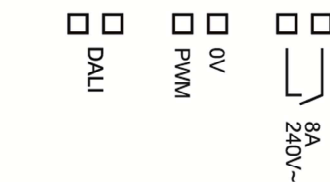

connection plan RM8 PWM

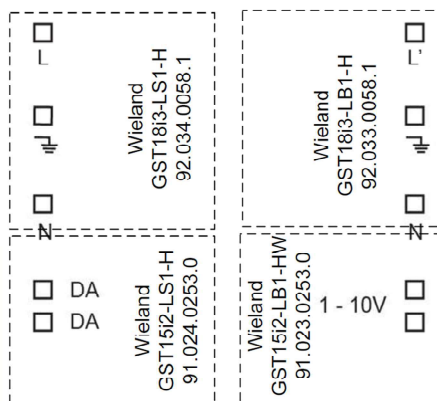

connection plan RM16 1-10V

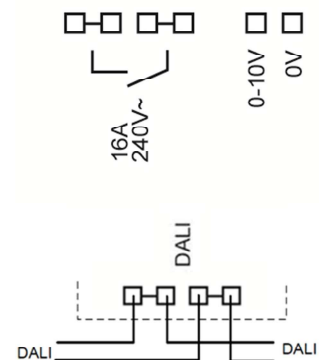

connection plan RM16 0-10V DE

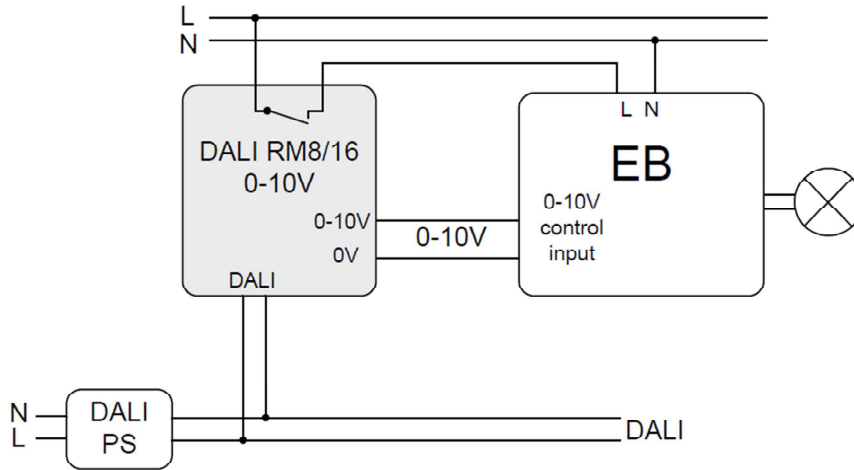

typical installation

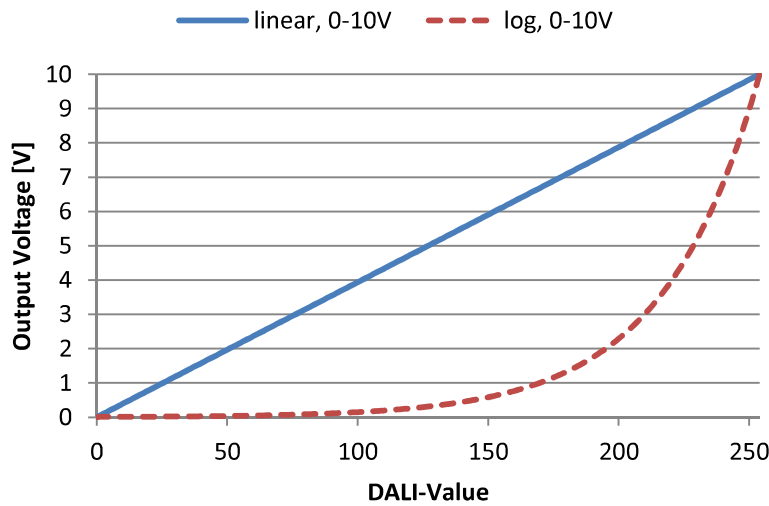

**Output Voltage 0-10V or 0-100%:**

control characteristic:

DALI 0-254 is converted to an output voltage of 0-10V (0%-100% PWM)

- linear
- - - logarithmic

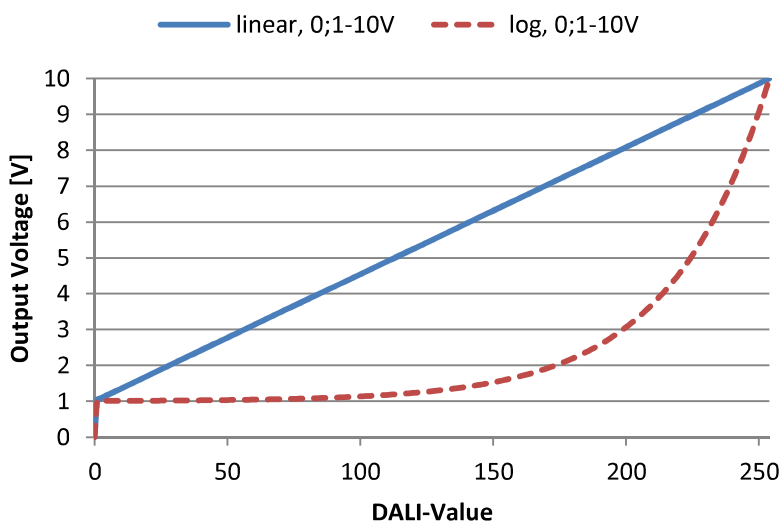

**Output Voltage 1-10V or 10-100%:**

control characteristic:

DALI 0 (=OFF) is converted to an output voltage <0,8V.

DALI 1-254 is converted to an output voltage of 1-10V (10%-100% PWM)

- linear
- - - logarithmic (factory default)

Hint: the voltage values in the characteristics are only valid if the device is supplied with 10V at the 0-10V output.

## Installation

The module has to be connected directly to the DALI line. It does not need any additional supply. Typical values of the current consumption depend on type and range from 3mA to 4.2mA. The connection to the DALI line is polarity free. Types providing PWM-output support sinking currents up to 2mA, the type with analog output sinking currents up to 1mA.

The SPST relay of the RM8 module support nominal loads of up to 1000VA. The RM16 type supports nominal loads of up to 2000VA and inrush currents up to 160A.

The terminals allow cross sections of the connecting wires from 0.5-1.5mm<sup>2</sup>.

## Function

The interface converts the desired DALI dim level into a corresponding PWM pattern or analog output voltage.

Up from firmware 2.0 device type 5 is supported. Therefore a linear and a logarithmic control characteristic are available. In addition for the PWM-Types the output range can be selected between 0-10V and 1-10V. The DALI value [0-254] is converted either linearly or logarithmic to the output range. The behaviour is shown in detail in the control characteristics.

The SPST-relay is directly linked to the 8-bit direct arc power level. If the value is 0 the relay is OFF, whereas at any other value [1...254] the relay is ON.

The combination of the 0-10V control signal and the additional SPST-relay offers the possibility to power on/off the mains supply of the 0-10V controlled electronic ballast.

In case of a system failure 100% (10V) are applied at the 0-10V control output. The behaviour of the relay depends on the

firmware version. In any case the relay holds the output state. In newer versions the system failure level can be set. The relay can be switched on or off or set to hold the current state (option available up from FW 3.5.0 at 86458667-DE, up from FW 3.3.0 at 86458668, and up from FW 1.3.0 at 86458668-AN).

## DALI-Befehlssatz

The module is based on the standard for DALI Control Gear (IEC 62386-102) and Device Type 5 extension (IEC 62386-206). With few exceptions mentioned above the entire instruction set defined by the DALI standard is supported. Furthermore the newer versions already support the DALI2-command GOTO LAST ACTIVE LEVEL.

## Auto Calibration Mode

In the DALI RM8 1-10V module with analog output an automatic calibration routine is implemented. After power up the module the stored calibration values are checked. If a new calibration is required a duration of up to 2 minutes has to be taken into account before the module can be used. The automatic calibration can be en-/disabled and triggered manually with the DALI Cockpit software tool. While the calibration is running the device does not react to any dimming commands.

## Additional Information and Equipment

DALI-Cockpit – free configuration tool from Lunatone for DALI systems

<http://lunatone.at/en/downloads/Lunatone-DALI-Cockpit.zip>

Lunatone DALI products

<http://www.lunatone.at/en/>

Lunatone datasheets and manuals

<http://lunatone.at/en/downloads/>

## Contact

Technical Support: [support@lunatone.com](mailto:support@lunatone.com)

Requests: [sales@lunatone.com](mailto:sales@lunatone.com)

[www.lunatone.com](http://www.lunatone.com)



## Disclaimer

Subject to change. Information provided without guarantee.  
The datasheet refers to the current delivery.

The compatibility with other devices must be tested in advance  
to the installation.