

50 W Dimmable DALI LED driver

Product code: 5543

50 W 220 – 240 VAC 50 – 60 Hz

- SELV output protection for safety and flexibility in luminaires
- DALI control input, 1-100 % dimming range
- Suitable for use with DC input
- Long lifetime up to 100 000 h
- Suitable for class I and class II luminaires
- Driver protection Class II
- For driving Class III (SELV) luminaires, optional strain relief available for independent use outside of luminaire (LC1x70-SR)



Functional Description

- Adjustable constant current output: 1050 mA (default) to 1400 mA
- Current setting programmable by Helvar driver configurator or by external resistors
- Hybrid dimming technique for high quality light
- Switch-control functionality for easy-to-use intensity control (Note: from product revision H onwards)
- Adaptive LED overload protection. Reduces output current if overload is detected
- Full load recognition, open and short circuit protection
- Multipurpose terminal Iset/NTC for current setting or over temperature protection
- Constant Light Output (CLO) (default disabled)
- Power consumption monitor (real time), Running hour monitor (accumulative, Energy management (accumulative))

Mains Characteristics

Voltage range	198 VAC – 264 VAC Withstands max. 320 VAC (max. 1 hour)
DC range	176 VDC - 280 VDC
starting voltage	> 190 VDC
Mains current at full load	0.22 A – 0.31 A
Frequency	0 / 50 Hz – 60 Hz
Stand-by power consumption	< 0.5 W
THD at full power	< 10 %
Tested surge protection	1 kV L-N, 2 kV L-GND (IEC 61000-4-5)
Tested fast transient protection	4 kV (IEC 61000-4-4)

Insulation between circuits

Mains circuit - SELV circuit	Double/reinforced insulation
DALI circuit - SELV circuit	Double/reinforced insulation
Mains circuit - DALI circuit	Basic insulation

Load Output (SELV <60 V)

Output current (I_{out})	1050 mA (default) – 1400 mA
Accuracy	± 5 %
Ripple	< 1 %* at ≤ 120 Hz
U_{out} (max) (abnormal)	60 V

*] Low frequency, LED load: Cree XM-L LEDs

I_{out}	1050 mA	1400 mA
P_{out} (max)	50.4 W	50.4 W
U_{out}	20 V – 48 V	20 V – 36 V
λ at full load	0.97	0.97
Efficiency (η) at full load	88 %	87 %

Operating window

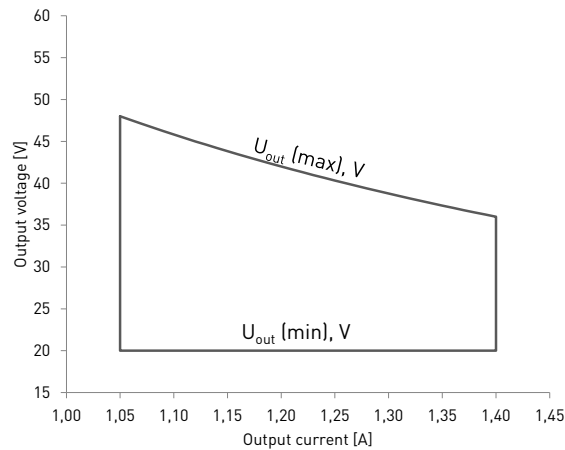

Note: Dimming between 1 % - 100 % possible across the whole operating window

Driver performance

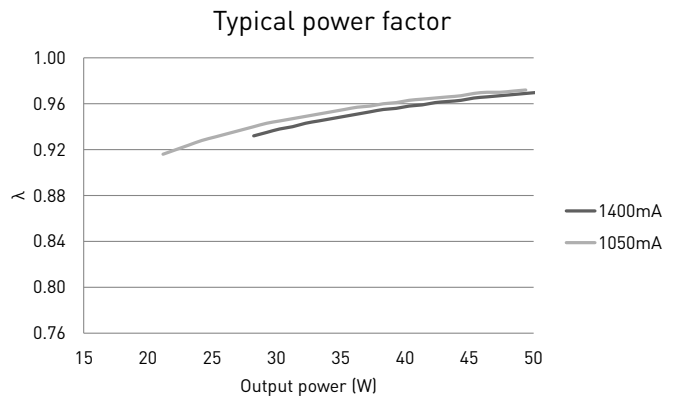
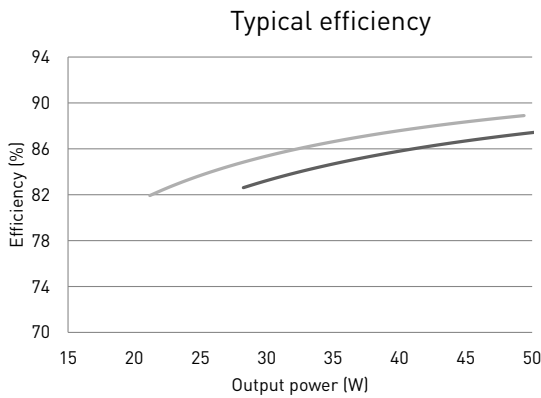

Operating Conditions and Characteristics

Highest allowed t_c point temperature	75 °C
Ambient temperature range	-20 °C ... +50 °C
in independent use	-20 °C ... +40 °C
Storage temperature range	-40 °C ... +80 °C
Maximum relative humidity	No condensation
Life time (90 % survival rate)	100 000 h, at $t_c = 65$ °C
	70 000 h, at $t_c = 70$ °C
	50 000 h, at $t_c = 75$ °C

Optional version available with coated PCB for improved robustness in challenging climate conditions (humidity, temperature).
 Coated version: Partially allowed condensation, ambient temperature range -30...+50 °C. Ambient temperature range in independent use -30...+45 °C.

Hybrid dimming technique per channel

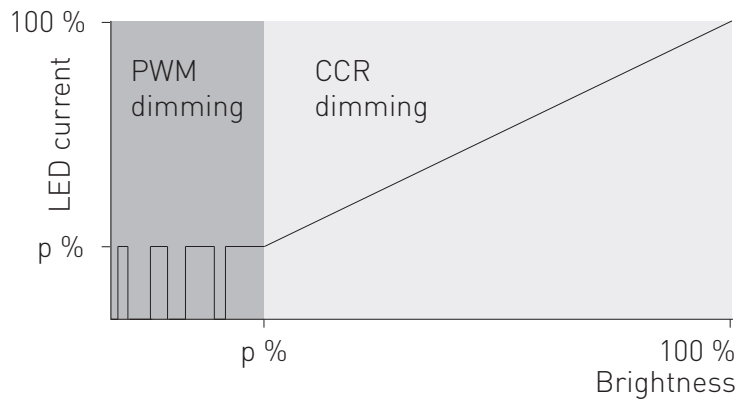

Dimming range/ch	Dimming technique
1 % – 20 %	Pulse Width Modulation (PWM)*
20 % – 100%	Constant Current Reduction (CCR)

* PWM dimming frequency 800 Hz

Helvar hybrid dimming products combines both Constant Current Reduction (CCR) amplitude dimming and Pulse Width Modulation (PWM) dimming. CCR is a very efficient technique for dimming the light output, especially on higher range. On lower range, the hybrid dimming products implement high-frequency PWM dimming according to the table above.

Quantity of drivers per miniature circuit breaker 16 A Type C

Based on I_{cont}	Based on inrush current I_{peak}	Typ. peak inrush current I_{peak}	1/2 value time, Δt	Calculated energy, $I_{peak}^2 \Delta t$
43 pcs.	61 pcs.	29 A	146 μs	0.097 A ² s

CONVERSION TABLE FOR OTHER TYPES OF MINIATURE CIRCUIT BREAKER

MCB type	Relative quantity of LED drivers
B 10 A	37 %
B 16 A	60 %
B 20 A	75 %
C 10 A	62 %
C 16 A	100 % (see table above)
C 20 A	125 %

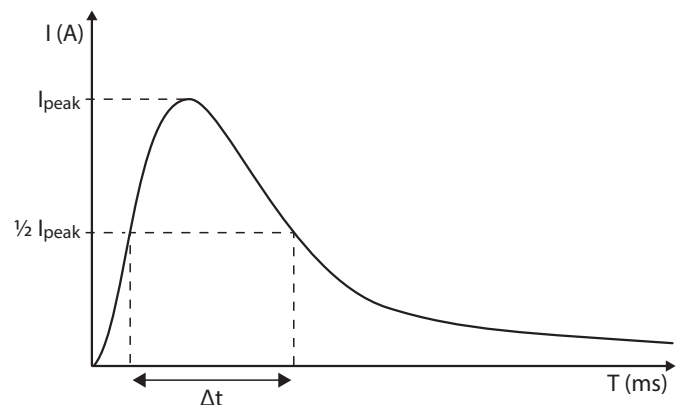

Type C MCB's are strongly recommended to use with LED lighting. Please see more details in "MCB information" document in each driver product page in "downloads & links" section.

Connections and Mechanical Data

Wire size	0.5 mm ² – 1.5 mm ²
Wire type	Solid core and fine-stranded
Wire insulation	According to EN 60598
Maximum driver to LED wire length	5 m
Weight	270 g
IP rating	IP20

Connections

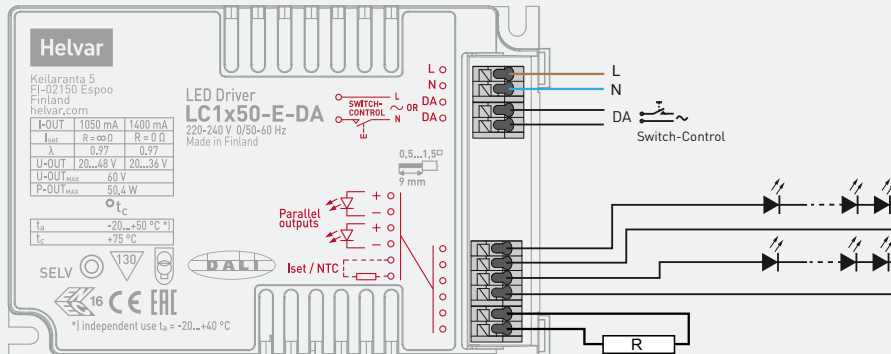

Note:

- Not suitable for load side switching operation
- Switch-Control enabled from product revision H onwards

Dimensions (mm)

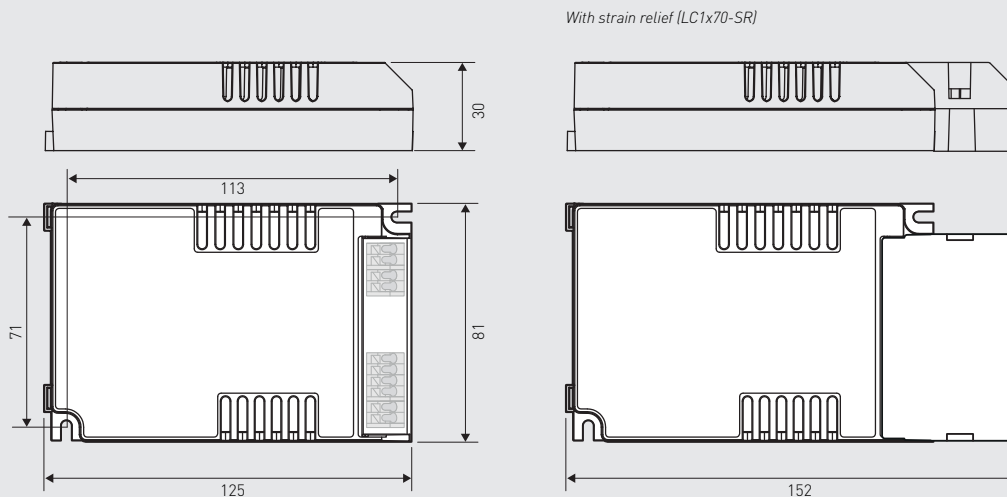

Output current can be set with the current setting resistor connected to the Iset terminal. Example current and resistor values across the range can be found in the following table. More information about the current setting resistor is given on page 5.

Current setting resistor values, Nominal I_{out} (±5 % tol.)

Resistor (Ω)	0	1k	2k2	3k3	4k7	8k2	10k	15k	22k	33k	47k	68k	100k	220k	∞
I _{out} (mA)	1400	1380	1360	1340	1320	1290	1270	1240	1200	1170	1140	1120	1100	1070	1050

LC1x50-E-DA LED driver is suited for inbuilt luminaire usage. In order to have safe and reliable LED driver operation, the LED luminaires will need to comply with the relevant standards and regulations (e.g. IEC/EN 60598-1). The LED luminaire shall be designed to adequately protect the LED driver from dust, moisture and pollution. The luminaire manufacturer is responsible for the correct choice and installation of the LED drivers according to the application and product datasheets. Operating conditions of the LED driver may never exceed the specifications as per the product datasheet.

Installation & operation

Maximum t_c temperature:

- Reliable operation and lifetime is only guaranteed if the maximum t_c point temperature is not exceeded under the conditions of use
- Ensure that the t_c point temperature does not rise higher than specified on the product datasheets

Installation site:

- The general preferred installation position of LED drivers for independent use is to have the top cover facing upwards

Current setting resistor

LC1x50-E-DA LED driver features an adjustable constant current output.

- When no external resistor is connected, then the LED drivers will operate at their default lowest current level
- A standard through-hole resistor can be used for the current setting. To achieve the most accurate output current it is recommended to select a quality low tolerance resistor. Minimum diameter for resistor leg is 0.51mm
- Always connect the current setting resistor only into the terminals marked with Iset on the LED driver label.
- Resistor/current values are presented on page 3

Lamp failure functionality

No load

When open load is detected, driver will go to standby. Automatic recovery is on during the first 10 minutes. If open load is still detected after the first 10 minutes, driver goes to standby mode and recovers through mains reset.

Short circuit

When short circuit is detected, driver goes to standby mode and returns through mains reset.

Overload

When high over load is detected, driver goes to standby mode and follows the same logic as described in the short circuit condition. When low over load is detected, output current will be reduced to have maximum rated output power.

Underload

When under voltage is detected, driver goes to standby mode and returns through mains reset.

Conformity & standards

General and safety requirements	EN 61347-1: 2008+ A1:2011+A2:2013
Particular safety requirements for DC or AC supplied electronic control gear for LED modules	EN 61347-2-13: 2014
Thermal protection class	EN 61347, C5e
Mains current harmonics	EN 61000-3-2: 2014
Limits for voltage fluctuations and flicker	EN 61000-3-3: 2013
Radio frequency interference	EN 55015: 2013
Immunity standard	EN 61547: 2009
Performance requirements	EN 62384: 2006+ A1:2009
Independent usage acc. to relevant clauses of	EN 60598-1 : 2015
Digital addressing lighting interface: General requirements for DALI system Requirements for DALI control gear Requirements for control gear of LED modules (Device Type 6)	EN 62386-101 EN 62386-102 EN 62386-207
Compliant with relevant EU directives	
ENEC and CE marked	

Label symbols



Safety isolating control gear with short circuit protection (SELV control gear).



Double insulated control gear suitable for built-in use.



Thermally controlled control gear, incorporating means of protection against overheating to prevent the case temperature under any conditions of use from exceeding 130 °C.

Company Address:
Helvar Oy Ab
Keilaranta 5
FI-02150, Espoo