

OPTOTRONIC Cable Clamp

Treiberzubehör



Anwendungsgebiete

- Downlights, flache Leuchten
- Geeignet für unterschiedliche Kabeltypen
- Geeignet für Installationen im Innenbereich

Produktvorteile

- Einfache und schnelle Befestigung der Kabel
- Ausreichend Platz zur Kabelverbindung
- Kostengünstige und platzsparende Lösung (TL-Version)
- Freier Kabelanschluß durch offen stehende Deckel
- Sofortige Installation dank vorkonfektionierten Kabelklemmen

Produkteigenschaften

- Sicherheit: nach EN 61347
- Einfach zu installierende und flexible Kabelklemmen
- Separate Kabelklemmen für Primär- und Sekundärseite
- Vormontierte, unverlierbare Schrauben
- Durchgangsverdrahtung (TL-Version)

Technische Daten

Abmessungen & Gewicht

Produkt-Bezeichnung	Länge	Breite	Höhe	Produkt-gewicht
OT CABLE CLAMP A-STYLE	35,0 mm	65,0 mm	25,0 mm	29,00 g
OT CABLE CLAMP B-STYLE	49,2 mm	57,7 mm	29,5 mm	26,00 g
OT CABLE CLAMP D-STYLE	38,5 mm	33,0 mm	29,5 mm	28,60 g
OT CABLE CLAMP E-STYLE	38,0 mm	53,0 mm	25,0 mm	16,00 g
OT CABLE CLAMP F-STYLE	38,0 mm	53,0 mm	30,0 mm	16,00 g
OT CABLE CLAMP A-STYLE TL	90,0 mm	92,0 mm	25,0 mm	80,00 g
OT CABLE CLAMP B-STYLE TL	90,0 mm	92,0 mm	29,5 mm	80,00 g

Produkt Grafik

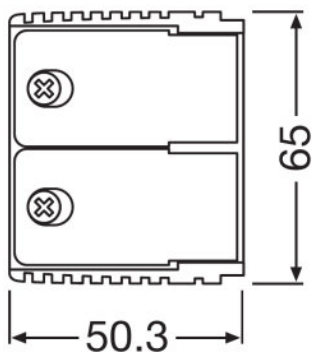

OT CABLE CLAMP A-STYLE

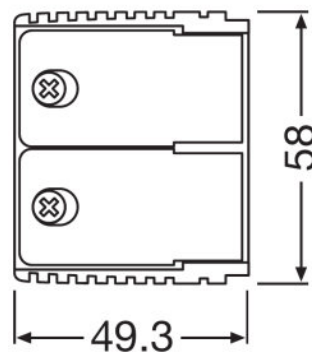

OT CABLE CLAMP B-STYLE

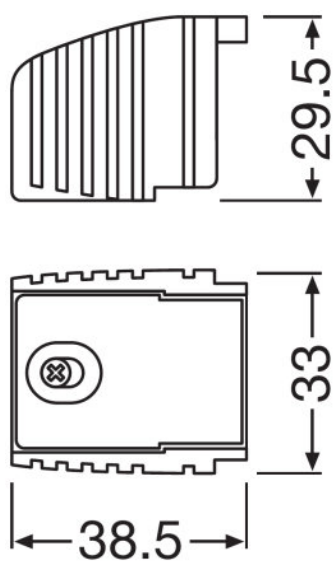

OT CABLE CLAMP D-STYLE

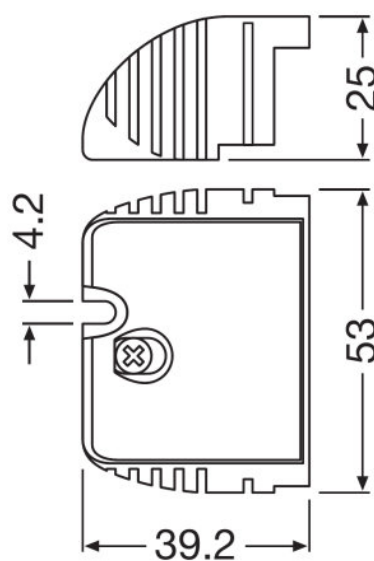

OT CABLE CLAMP E-STYLE

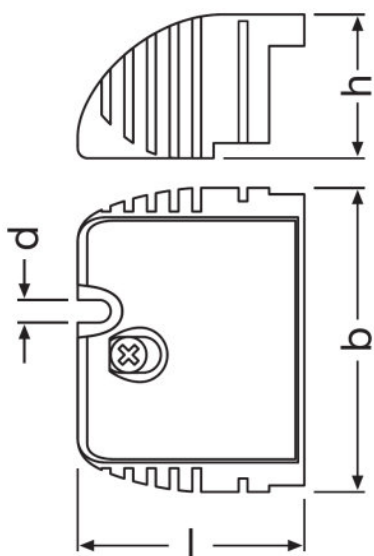

OT CABLE CLAMP F-STYLE

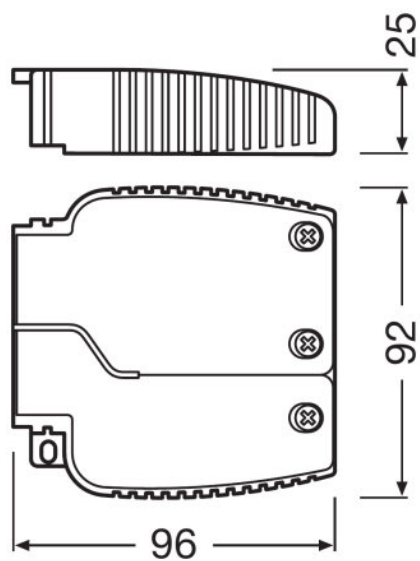

OT CABLE CLAMP A-STYLE TL

Familiendatenblatt

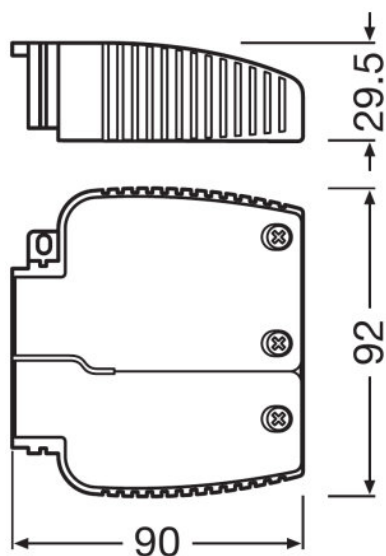

OT CABLE CLAMP B-STYLE TL







Anwendungshinweis

Für weitere Anwendungsinformationen beachten Sie bitte das Produktdatenblatt





Verkaufs- und Technischer Support

Verkaufs- und Technischer Support www.osram.de

Downloads

Datei	
	Produktdatenblatt 350858_Datasheet OT CABLE CLAMP B-STYLE
	Produktdatenblatt 497315_OT CABLE CLAMP D-STYLE
	Produktdatenblatt 498136_OT Technical DS - Cable Clamp E style
	Produktdatenblatt 637617_Preliminary DS OT CABLE CLAMP F-STYLE (GB)
	CAD Daten 673587_CAD Data OT-CableClamp-F-Style
	CAD Daten 673588_CAD Data OT-CableClamp-F-Style
	CAD-Daten PDF 673589_CAD Data OT-CableClamp-F-Style

Familiendatenblatt

	Anhang TI 592682_Cable Clamp B-Sytle Driver Assembly
	Installationshinweise 547465_OT Cable Clamp TL-B Instructions sheet
	CAD Daten 3-dim 592683_Cable Clamp B-Sytle STEP
	CAD Daten 3-dim 592684_Cable Clamp B-Sytle IGS

Verpackungsinformationen

Produkt-Code	Produkt-Bezeichnung	Verpackungseinheit (Stück pro Einheit)	Abmessungen (Länge x Breite x Höhe)	Volumen	Gewicht brutto
4052899089570	OT CABLE CLAMP A-STYLE	Versandschachtel 20	336 mm x 110 mm x 68 mm	2.51 dm ³	672.00 g
4052899077881	OT CABLE CLAMP B-STYLE	Versandschachtel 20	300 mm x 107 mm x 76 mm	2.44 dm ³	625.00 g
4052899077904	OT CABLE CLAMP D-STYLE	Versandschachtel 40	178 mm x 84 mm x 141 mm	2.11 dm ³	1221.00 g
4052899167896	OT CABLE CLAMP E-STYLE	Versandschachtel 20	275 mm x 85 mm x 64 mm	1.50 dm ³	380.00 g
4052899325555	OT CABLE CLAMP F-STYLE	Versandschachtel 20	278 mm x 87 mm x 70 mm	1.69 dm ³	383.00 g
4052899325982	OT CABLE CLAMP A-STYLE TL	Versandschachtel 20	470 mm x 188 mm x 77 mm	6.80 dm ³	1885.00 g
4052899948051	OT CABLE CLAMP B-STYLE TL	Versandschachtel 20	470 mm x 188 mm x 77 mm	6.80 dm ³	1885.00 g

Die genannten Produktnummern beschreiben die kleinste bestellbare Mengeneinheit. Eine Versandeinheit kann mehrere Einzelprodukte beinhalten. Als Bestellmenge verwenden Sie bitte das Ein- oder Mehrfache einer Versandeinheit.

Haftungsausschluss

Änderungen und Irrtümer vorbehalten. Vergewissern Sie sich, dass Sie immer den neuesten Stand verwenden.