

Components for luminaires

Catalogue



2 **Zalux**

4 **Luminaires Kit**

Including housing, diffuser, gear tray and accessories

6 DUNA



8 ACQUA



10 ALHAMA



12 PE



14 **Single Parts**

Individual components

16 ACQUA / ALHAMA / DUNA

18 PE

19 Accessories

20 **Technical information**

20 Resistance to chemical agents

21 Ingress and impact protection

22 **General sale conditions**

Foundation **1980**

Components
for luminaires
per year **3.5M**

Employees **360**

Countries
with market
presence **75**

zalux





ZALUX is the European OEM leader for weatherproof luminaires and components.

Specialised in the OEM development and manufacturing of reliable and durable luminaires for extreme conditions such as a wide range of temperatures, dust, humidity and chemicals.

PROTECTED LUMINAIRES



Efficient and quality luminaires specific for different industrial applications, with a wide range of options.

OEM AND COMPONENTS FOR LUMINAIRES



OEM design, engineering and manufacturing of bespoke lighting products to meet special needs.

ATEX LUMINAIRES



Explosion proof LED luminaires certified for use in EX-Zones according to ATEX directive.



- Headquarters in Zaragoza, Spain
- 3 manufacturing plants in Alhama de Aragón
- Quality Made in Spain



ALHAMA I

- Plastic injection
- Compression press
- Extrusion



ALHAMA II

- Metal workshop
- Automated wiring robots
- 20 assembly lines for LED
- Electronic components assembling



ALHAMA III

- New assembling area
- 1500m² premises
- 13 production lines



LABORATORY

- Thermal and endurance tests
- IPX5 – X6 humidity tests
- Impact tests
- Product safety tests



WAREHOUSE

- 10,000m² storage
- For 5,800 Europallets
- With advanced computer systems



Luminaires kit

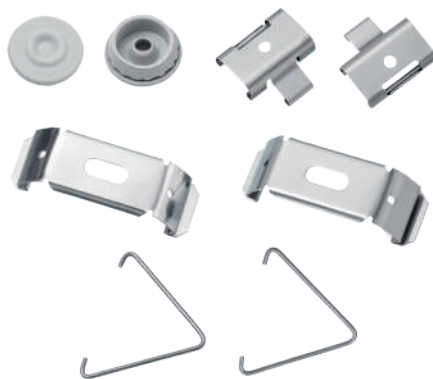
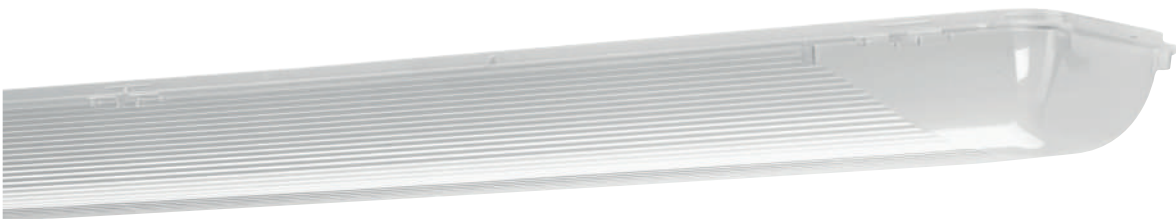

DUNA



Usual applications:

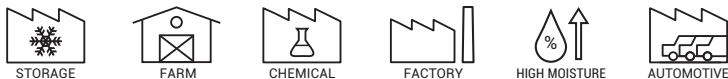

Characteristics

Housing	Compressed fibreglass reinforced polyester (GRP), or injected polycarbonate (PC) Grey RAL 7035
Gasket	Polyurethane
Gear tray	White lacquered steel plate for LED modules
Gear tray holders	Wide version, to fix the gear tray to the housing and to suspend the gear tray to facilitate connection
Diffuser	Injected UV protected opal diffuser, with frosted finish to achieve a uniform and optimised light distribution, specific for LED PC: impact resistance IK08 PMMA: high chemical resistance IK03 and better transmittance

DUNA DIFFUSER

Texturised opal
1,2 and 1.5 versions only

ALHAMA DIFFUSER

Prismatic opal
Complete range

Accessory bag

Closing clips	Plastic (polyamide) or stainless steel (INOX)
Fixing clips, suspension triangles	Stainless steel
Cable entry	Grommet



Accessory bag with plastic clips

Dimensions and logistics

	X	Xm	Y	Z DUNA	Z ALHAMA					
	mm	mm	mm	mm	mm	L x W x H mm	Kits/Box	Box	Groupage Pcs./pallet	Groupage/full truck Pcs./double pallet
1 x 0.6	660	390	101	84	101	675 x 105 x 80	1	1.02	294	168 + 168
1 x 1.2	1279	800	101	84	101	1290 x 105 x 80	1	2.03	147	84 + 84
1 x 1.5	1573	1100	101	84	101	1590 x 105 x 80	1	2.49	147	84 + 84
2 x 0.6	660	390	145	84	101	675 x 150 x 80	1	1.28	210	120 + 120
2 x 1.2	1279	800	145	84	101	1290 x 150 x 80	1	2.57	105	60 + 60
2 x 1.5	1573	1100	145	84	101	1590 x 150 x 80	1	3.13	105	60 + 60

For logistic estimations please contact our sales backoffice team

DUNA DIFFUSER

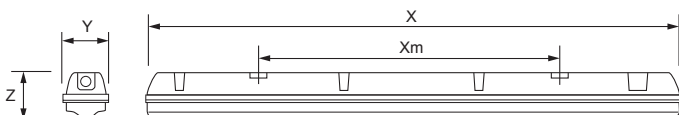

ALHAMA DIFFUSER

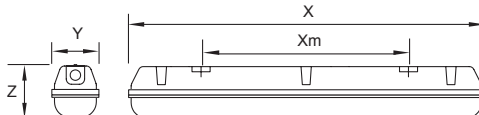

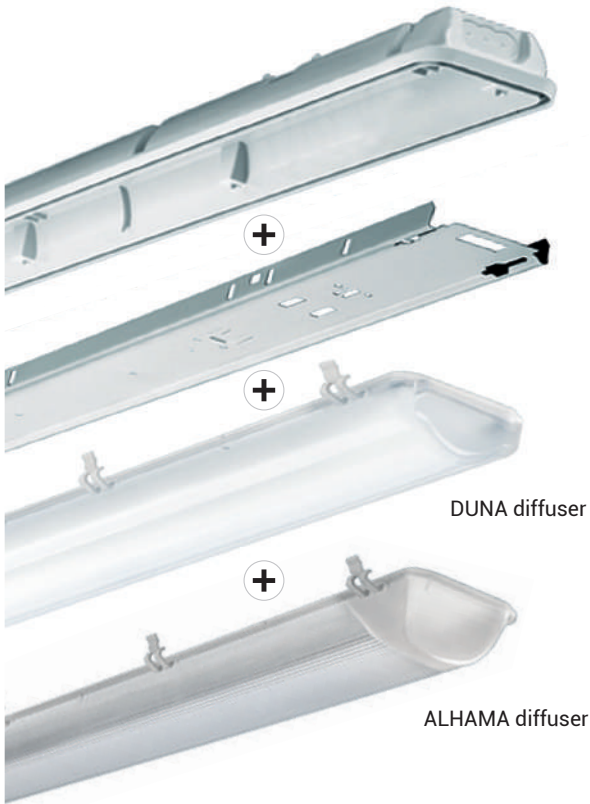

KIT are presented in an individual box comprising:

- Housing
- Gear tray
- Gear tray holders
- Diffuser
- Accessory bag

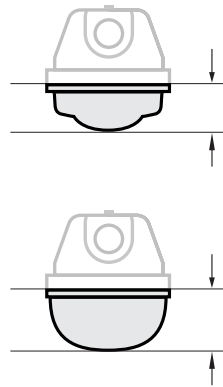

Order numbers

DUNA PC

PC housing + DUNA PC diffuser

	Plastic closing clips	
	Removable	Unremovable
1 x 1.2	10210340	10174387
1 x 1.5	10174392	10174391

DUNA GRP

GRP housing + DUNA PMMA diffuser

	INOX closing clips	
	Removable	Unremovable
1 x 1.2	10174390	10174389
1 x 1.5	10174394	10174393

PC housing + ALHAMA PC diffuser

	Plastic closing clips	
	Removable	Unremovable
1 x 0.6	10174396	10174395
1 x 1.2	10174400	10174399
1 x 1.5	10174404	10174403
2 x 0.6	10174408	10174407
2 x 1.2	10174412	10174411
2 x 1.5	10174416	10174415

GRP housing + ALHAMA PMMA diffuser

	INOX closing clips	
	Removable	Unremovable
1 x 0.6	10174398	10174397
1 x 1.2	10174402	10174401
1 x 1.5	10174406	10174405
2 x 0.6	10174410	10174409
2 x 1.2	10174414	10174413
2 x 1.5	10174418	10174417

Please consult our Sales Team for any other combination

ACQUA



Usual applications:



Characteristics

Housing	Compressed fibreglass reinforced polyester (GRP) Grey RAL 7035
Gasket	High quality bi-component polyurethane for extreme durability
Gear tray	White lacquered steel plate for T5 and T8
Gear tray holders	Wide version, to fix the gear tray to the housing and to suspend the gear tray to facilitate connection
Diffuser	Injected UV protected transparent diffuser with prismatic design for an optimum light distribution PC: impact resistance IK08 PMMA: high chemical resistance IK03 and better transmittance

Accessory bag

Closing clips	Plastic (polyamide) or stainless steel (INOX)
Fixing clips, suspension triangles	Stainless steel
Cable entry	Grommet



Accessory bag with INOX clips



Accessory bag with plastic clips

Dimensions and logistics

	X	Xm	Y	Z					
	mm	mm	mm	mm	L x W x H mm	Kits/Box	Box	Groupage Pcs./pallet	Groupage/full truck Pcs./double pallet
1 x 0.6	662	390	101	101	675 x 105 x 80	1	1.02	294	168 + 168
1 x 1.2	1283	800	101	101	1290 x 105 x 80	1	2.03	147	84 + 84
1 x 1.5	1573	1100	101	101	1590 x 105 x 80	1	2.49	147	84 + 84
2 x 0.6	662	390	145	101	675 x 150 x 80	1	1.28	210	120 + 120
2 x 1.2	1283	800	145	101	1290 x 150 x 80	1	2.57	105	60 + 60
2 x 1.5	1573	1100	145	101	1590 x 150 x 80	1	3.13	105	60 + 60

For logistic estimations please contact our sales backoffice team

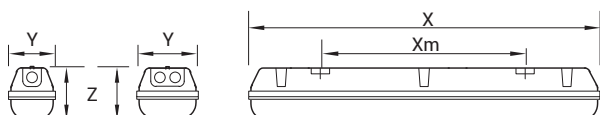

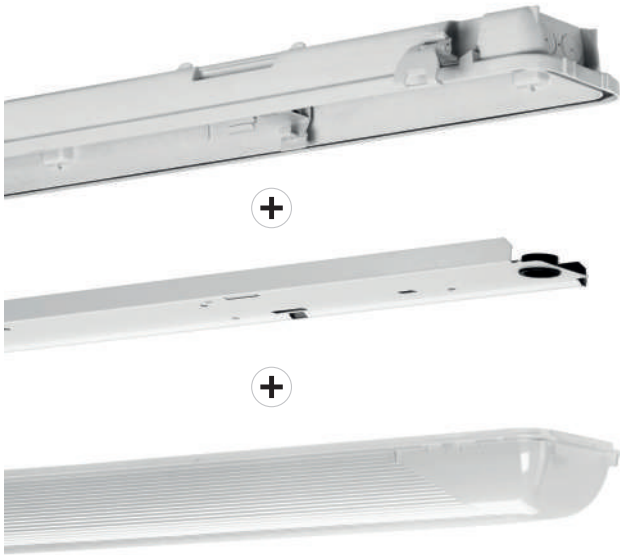

KIT are presented in an individual box comprising:

- Housing
- Gear tray
- Gear tray holders
- Diffuser
- Accessory bag

Order numbers

ACQUA PC

GRP housing + PC diffuser

	Plastic closing clips		INOX closing clips
	T8	T5 or T8	T8
1 x 0.6	10048346	10088279	10048558
1 x 1.2	10048347	10088280	10048559
1 x 1.5	10048348	10088281	10048560
2 x 0.6	10048349	10088347	10048561
2 x 1.2	10048350	10088348	10048562
2 x 1.5	10048351	10088349	10048563

ACQUA PMMA

GRP housing + PMMA diffuser

	Plastic closing clips		INOX closing clips
	T8	T5 or T8	T8
1 x 0.6	10048352	10070297	10048564
1 x 1.2	10048353	10070298	10035612
1 x 1.5	10048354	10070299	10048565
2 x 0.6	10048355	10070300	10035613
2 x 1.2	10048356	10070301	10035611
2 x 1.5	10048357	10070302	10048566

ALHAMA



Usual applications:



Characteristics

Housing	Injected polycarbonate (PC) Grey RAL 7035
Gasket	High quality bi-component polyurethane for extreme durability
Gear tray	White lacquered steel plate for T5 and T8
Gear tray holders	Narrow version, to fix the gear tray to the housing and to suspend the gear tray to facilitate connection
Diffuser	Injected UV protected transparent diffuser with prismatic design for an optimum light distribution PC: impact resistance IK08 PMMA: high chemical resistance IK03 and better transmittance

Accessory bag

Closing clips	Plastic (polyamide) or stainless steel (INOX)
Fixing clips, suspension triangles	Stainless steel
Cable entry	Grommet







Accessory bag with INOX clips



Accessory bag with plastic clips

Dimensions and logistics

	X	Xm	Y	Z					
	mm	mm	mm	mm	L x W x H mm	Kits/Box	Box	Groupage Pcs./pallet	Groupage/full truck Pcs./double pallet
1 x 0.6	657	390	101	101	670 x 105 x 75	1	0.93	294	168 + 168
1 x 1.2	1279	800	101	101	1280 x 105 x 75	1	1.89	147	84 + 84
1 x 1.5	1573	1100	101	101	1580 x 105 x 75	1	2.26	147	84 + 84
2 x 0.6	657	390	145	101	670 x 155 x 75	1	1.20	210	120 + 120
2 x 1.2	1279	800	145	101	1280 x 155 x 75	1	2.43	105	60 + 60
2 x 1.5	1578	1100	145	101	1580 x 155 x 75	1	2.89	105	60 + 60

For logistic estimations please contact our sales backoffice team

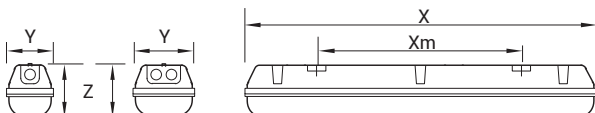



KIT are presented in an individual box comprising:

- Housing
- Gear tray
- Gear tray holders
- Diffuser
- Accessory bag

Order numbers

ALHAMA PC

PC housing + PC diffuser

	Plastic closing clips		INOX closing clips
	T8	T5 or T8	T8
1 x 0.6	10020049	10100800	10020051
1 x 1.2	10019877	10099728	10019879
1 x 1.5	10019937	10100801	10019939
2 x 0.6	10020101	10100802	10020103
2 x 1.2	10017594	10099729	10017595
2 x 1.5	10019997	10100803	10019999

ALHAMA PMMA

PC housing + PMMA diffuser

	Plastic closing clips		INOX closing clips
	T8	T5 or T8	T8
1 x 0.6	10020052	10100804	10020054
1 x 1.2	10019880	10100805	10019882
1 x 1.5	10019940	10100806	10019942
2 x 0.6	10020104	10100807	10020106
2 x 1.2	10017599	10100808	10017600
2 x 1.5	10020000	10100809	10020002

PE



Usual applications:



Characteristics

Housing	Compressed fibreglass reinforced polyester (GRP) Grey RAL 7035
Gear tray	White lacquered steel plate
Diffuser	Injected UV protected transparent diffuser with prismatic design for an optimum light distribution PC: impact resistance IK07 PMMA: high chemical resistance IK03 and better transmittance

Accessory bag

Closing clips	Plastic (polyamide) or stainless steel INOX
Washers	Rubber Flat
Cable entry	Grommet







INOX closing clips



Plastic closing clips

Dimensions and logistics

	X	Xm	Y	Z					
	mm	mm	mm	mm	L x W x H mm	Kits/Box	Box	Groupage Pcs./pallet	Groupage/full truck Pcs./double pallet
1 x 0.6	666	230	100	108	675 x 110 x 95	1	1.02	224	140 + 140
1 x 1.2	1275	840	100	108	1285 x 110 x 95	1	2.03	112	70 + 70
1 x 1.5	1575	1140	100	108	1585 x 110 x 95	1	2.49	112	70 + 70
2 x 0.6	666	230	170	108	675 x 175 x 95	1	1.28	128	80 + 80
2 x 1.2	1275	840	170	108	1285 x 175 x 95	1	2.57	64	40 + 40
2 x 1.5	1575	1140	170	108	1580 x 155 x 75	1	2.89	64	40 + 40

For logistic estimations
please contact our sales
backoffice team

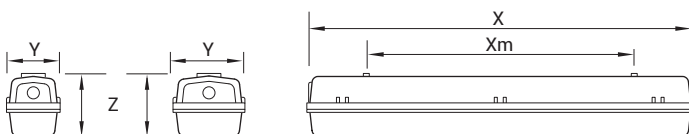



KIT are presented in an individual box comprising:

- Housing
- Gear tray
- Turnbuckle
- Diffuser
- Accessory bag

Order numbers

PEP

GRP housing + PC diffuser

	Plastic closing clips	INOX closing clips
1 x 0.6	10012175	10012177
1 x 1.2	10012218	10012220
1 x 1.5	10012274	10015449
2 x 0.6	10012332	10012334
2 x 1.2	10007411	10012379
2 x 1.5	10012438	10015450

PEM

GRP housing + PMMA diffuser

	Plastic closing clips	INOX closing clips
1 x 0.6	10012491	10015103
1 x 1.2	10007416	10014666
1 x 1.5	10012600	10015106
2 x 0.6	10012651	10015104
2 x 1.2	10007420	10015105
2 x 1.5	10012763	10015107



Single parts



Housing



Gear tray



Diffuser





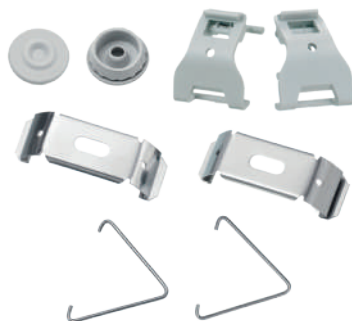



Gear tray holder



Accessories







Housing

		Order number					
			Units/Box	Box	Box/Pallet	Box/Pallet	
	ACQUA GRP	1 x 0.6	10118008	120	29	8	10
		1 x 1.2 ¹	10118009	125	57	4	5
		1 x 1.5 ¹	10118010	125	71	4	5
		2 x 0.6	10118011	75	24	8	10
		2 x 1.2	10118012	70	44	4	5
		2 x 1.5	10118014	70	52	4	5
	ALHAMA PC	1 x 0.6	10099521	120	29	8	10
		1 x 1.2 ¹	10099542	120	57	4	5
		1 x 1.5 ¹	10099543	120	71	4	5
		2 x 0.6	10099544	75	24	8	10
		2 x 1.2	10099545	75	44	4	5
		2 x 1.5	10099546	75	52	4	5

All housings are compatible with ALHAMA diffusers

¹Also compatible with DUNA diffuser

Diffuser

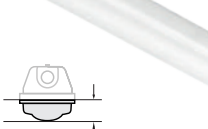
		Order number						
		PC	PMMA	Units/Box	Box	Box/Pallet	Box/Pallet	
	ALHAMA transparent	1 x 0.6	10020697	10109202	200	45	8	10
		1 x 1.2	10020701	10111261	200	87	4	5
		1 x 1.5	10020703	10111240	200	104	4	5
		2 x 0.6	10020699	10111241	130	38	8	10
		2 x 1.2	10017591	10111262	130	71	4	5
		2 x 1.5	10020705	10111242	130	87	4	5
	ALHAMA semi opal	1 x 0.6	10124902	10140241	200	45	8	10
		1 x 1.2	10117363	10120962	200	87	4	5
		1 x 1.5	10124903	10115727	200	104	4	5
		2 x 0.6	10125953	10146041	130	38	8	10
		2 x 1.2	10122361	10146042	130	71	4	5
		2 x 1.5	10122364	10146043	130	87	4	5
	DUNA ² opal	1 x 1.2	10138722	10138723	240	45	4	5
		1 x 1.5	10138724	10138725	240	87	4	5

²Slimmer diffuser specially designed for high performance of LED luminaires

Transparent diffusers are recommended for T5 and T8. Semi opal diffusers are recommended for LED modules.
Supplied in bulk packages. For logistic estimations please contact our sales backoffice team.

Gear tray



		Order number	Order number				
		LED 32 + 40 mm ZHAGA	LED 24 mm ZHAGA	Units/Box	Box	Box/Pallet	Box/Pallet
LED	1 x 0.6	10140240 ¹	10165083	460	130	2	2
	1 x 1.2	10136502 ¹	10145649 ¹	460	261	1	1
	1 x 1.5	10136503 ¹	10145650 ¹	460	325	1	1
	2-1 x 0.6	10145646 ¹	10155603	270	101	2	2
	2-1 x 1.2	10145647 ¹	10145651 ²	270	195	1	1
	2-1 x 1.5	10145648 ¹	10145652 ²	270	260	1	1

¹ It requires wide gear tray holder. ² It requires narrow gear tray holder.



		Order number	Order number	Order number				
		T8	T5 or T8 ³	T5	Units/Box	Box	Box/Pallet	Box/Pallet
T5 T8	1 x 0.6	10020719	10075943	10020717	460	130	2	2
	1 x 1.2	10020723	10075944	10020721	460	261	1	1
	1 x 1.5	10020727	10075945	10020725	460	325	1	1
	2 x 0.6	10020731	10075946	10020729	270	101	2	2
	2 x 1.2	10017590	10075967	10075971	270	195	1	1
	2 x 1.5	10020735	10075968	10020733	270	260	1	1

³Universal

Gear tray holder⁴

For GRP housing

		Order number
LED	Wide gear tray holder for GRP housing (LED module)	10119008
T5-T8	Narrow gear tray holder for GRP housing (T8-T5-LED tube)	10025876



Wide



Narrow

For PC housing

		Order number
LED	Wide gear tray holder set for PC housing (LED module)	Set: 10120146 + 10016244
T5-T8	Narrow gear tray holder set for PC housing (T8-T5-LED tube)	Set: 10027074 + 10016244



Wide set



Narrow set

⁴Each luminaire requires 2 pieces.

Accessories

For GRP housing

Closing clips	Accessory bag			Single clip
	0.6	1.2	1.5	
Plastic	10025986	10025987	10025988	10025869
INOX	10026906	10026907	10026908	10026905



Accessory bag with plastic clips



Accessory bag with INOX clips

For PC housing

Closing clips	Accessory bag			Single clip
	0.6	1.2	1.5	
Plastic, removable	10020763	10016237	10020765	10016239
Plastic, unremovable	10125240	10125241	10125242	50123987
INOX, removable	10020764	10016238	10020766	10016245



Accessory bag with plastic clips



Accessory bag with INOX clips

Supplied in bulk packages. For logistic estimations please contact our sales backoffice team

The products in this catalogue are OEM components requiring final assembly by a qualified OEM manufacturer. Data subject to change.

Housing



	Order number		Units/Box	KG Box	Box/Pallet	Box/Pallet
	With plastic clips	With INOX clips				
1 x 0.6	10012916	10012919	72	51	8	8
1 x 1.2	10012920	10012925	72	78	4	4
1 x 1.5	10012926	10012930	72	98	4	4
2 x 0.6	10012932	10012935	40	39	8	8
2 x 1.2	10012936	10012940	40	59	4	4
2 x 1.5	10012941	10012944	40	77	4	4

Gear tray



	Order number	Units/Box	KG Box	Box/Pallet	Box/Pallet
	T8				
1 x 0.6	10013279	500	130	2	2
1 x 1.2	10013281	500	261	1	1
1 x 1.5	10013283	500	325	1	1
2 x 0.6	10013285	250	101	2	2
2 x 1.2	10013286	250	195	1	1
2 x 1.5	10013288	250	260	1	1

Diffuser

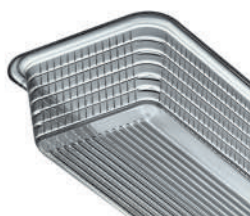

	Order number		Units/Box	KG Box	Box/Pallet	Box/Pallet
	PC	PMMA				
1 x 0.6	10012909	10013000	125	30	8	8
1 x 1.2	10012910	10013002	125	59	4	4
1 x 1.5	10012911	10013004	125	70	4	4
2 x 0.6	10012912	10013005	70	25	8	8
2 x 1.2	10012913	10013007	70	42	4	4
2 x 1.5	10012914	10013009	70	54	4	4

Accessories

Accessory bag

Closing clips	Luminaire length m			Single clip
	0.6	1.2	1.5	
Plastic	10022536	10022535	10022534	17172
INOX	429411	50027015	50027016	30004739



Accessory bag with plastic clips



Accessory bag with INOX clips

Mounting accessories

Suspension kit

414551



Description	Order number
-------------	--------------

Suspension kit 414551



Rubber seal RAL 7035 10013258



Suspension strap 10089857



Turnbuckle 10013056



Cable gland 10052840



Metalic nut M-5 10010863



Description	Order number
-------------	--------------

Cable holder 10014993



Elastic tight washer 30005948



Suspension triangle 60622



Metalic washer M-5 56032



Fixing clip 64582



Suspension wire 2 m with snap hook and express fastener 10103049



Resistance to chemical agents

Chemical agents	Polyester	Polycarbonate	Aluminium	PMMA	Stainless steel
Acetic acid 10%	✓	✓	✓	✓	✓
Acetone	∅	X	✓	X	✓
Alcoholic beverages	✓	✓	✓	∅	✓
Aluminium sulphate	✓	✓	✓	✓	∅
Ammonia 5%	∅	X	✓	✓	✓
Aniline	∅	X	✓	X	✓
Arsenic acid 20%	∅	✓	✓	✓	✓
Benzene	X	X	✓	X	∅
Bencylic alcohol	X	X	∅	X	∅
Bromine	X	X	X	X	X
Calcium Chloride	✓	✓	✓	✓	∅
Calcium nitrate	✓	✓	✓	✓	∅
Carbon tetrachloride	X	X	✓	X	∅
Carbonic acid	✓	X	✓	X	✓
Caustic potash 5%	X	X	X	✓	∅
Cement	✓	✓	✓	✓	∅
Hydrochloric acid 1-5%	∅	✓	X	✓	X
Chlorine liquids (vapours)	X	X	X	X	∅
Chloroform	X	X	✓	X	✓
Chromic acid	X	∅	X	∅	∅
Citric acid 20%	✓	✓	✓	✓	∅
Copper sulphate	✓	✓	X	✓	∅
Diesel-naphta oil	✓	∅	✓	✓	✓
Ethyl alcohol 30%	✓	✓	✓	∅	✓
Ethyl chloride	X	X	∅	X	✓
Ethyl ether	✓	X	✓	X	∅
Food oils and fats	✓	X	✓	✓	✓
Formic acid 10%	∅	✓	X	✓	∅
Glycerine	✓	✓	✓	✓	✓
Hexane	∅	✓	✓	✓	✓
Iodine	✓	X	∅	✓	X
Isopropyl alcohol	✓	∅	✓	∅	∅
Lubricating oil	✓	✓	✓	✓	✓
Magnesium sulphate	✓	✓	✓	✓	✓
Methanol	✓	X	✓	∅	✓
Mineral oils	✓	✓	✓	✓	✓
Nitric acid 20%	X	∅	X	✓	✓
Oxygen	✓	✓	✓	✓	✓
Ozone	✓	✓	✓	✓	∅
Perchloric acid 10%	X	✓	X	✓	X
Petrol	✓	X	✓	✓	✓
Phenol	∅	X	✓	X	∅
Potassium bromide	✓	✓	∅	✓	∅
Potassium nitrate	✓	✓	✓	✓	∅
Potassium permanganate	✓	✓	✓	✓	∅
Sea climate	✓	✓	∅	✓	∅
Silicon oils	✓	✓	✓	∅	✓
Soda bleach 15%	✓	X	∅	✓	∅
Sodium chloride	✓	✓	∅	✓	∅
Sodium hydroxide 5%	✓	X	X	✓	∅
Sodium sulphate	✓	✓	✓	✓	∅
Sugar	✓	✓	✓	✓	✓
Sulphur	✓	✓	✓	✓	∅
Sulphuric acid 30%	X	✓	X	✓	X
Toluene	X	X	✓	X	✓
Trichloroethylene	X	X	✓	X	∅
Zinc sulphate	✓	✓	∅	✓	∅

- ✓ Resistant
- ∅ Relatively resistant
- X Non-resistant

This is a recommendation about the compatibility of equivalent or similar chemical agents included in the composition of the cleaning products with the polymers present in the luminaires. It is based on information from material suppliers, available documentation, tests and our experience in different applications.

Materials resistance can be also affected by concentration, temperature, presence of various chemicals, solvent evaporation and other factors, so this table must be considered as a general reference. Product compliance must be determined by the customer for each specific use.

Ingress protection: IP

The protection of luminaires against the penetration of dust, solid matter and dampness is in accordance with UNE-EN 60529:2018 standard¹.

↓ IP66

Protection against the penetration of solid matter and dust.

0	Unprotected
1	Protected against solid matter greater than 50 mm
2	Protected against solid matter greater than 12 mm
3	Protected against solid matter greater than 2.5 mm
4	Protected against solid matter greater than 1 mm (e.g. small tools, small cables, etc.)
5	Protected against dust (without damaging sediment)
6	Protected against dust

Impact protection: IK

↓↓ IK08

00	Unprotected
01	Impact Energy 0.15 Joules
02	Impact Energy 0.20 Joules
03	Impact Energy 0.35 Joules
04	Impact Energy 0.50 Joules
05	Impact Energy 0.70 Joules
06	Impact Energy 1 Joule
07	Impact Energy 2 Joules
08	Impact Energy 5 Joules
09	Impact Energy 10 Joules
10	Impact Energy 20 Joules

↓ IP66

Protection against the penetration of liquids.

0	Unprotected
1	Protected against vertical water splashes (condensation)
2	Protected against water splashes of up to 15° of the vertical
3	Protected against water splashes of up to 60° of the vertical
4	Protected against water projections in all directions
5	Protected against water assault in all directions
6	Protected against water assault similar to heavy seas
7	Protected against immersion
8	Protected against prolonged effects of underwater immersion
9K ²	Protected against high-pressure / steam-jet cleaning ² .

²The third figure K is in accordance with ISO 20653:2013 standard, related to the protection of electrical equipment against foreign objects, water and access.

¹ IP degree is subject to the rest of the components used to complete the luminaire, and needs to be tested accordingly.

Our acceptance of an order entails, in any event, that the buyer accepts the following general conditions of sale and supply:

1. Source of supply

ZALUX luminaires can be obtained through our established network of distributors in the different countries.

2. Offers

The written, oral and telephone offers are without compromise. The delivery of offers does not oblige us to accept the order. All orders and compromises are only valid if we have expressly ratified them in writing.

3. Prices

The prices of the Price List in force are understood to be for materials in stock. We reserve the right to modify the prices; if it is possible, said variation will be communicated in the best possible time.

4. Delivery time

Delivery time will be confirmed individually once the order is accepted. Delivery time set by ZALUX, S.A., will be respected and only modified due to production or force majeure. Delay will be communicated to the customer in advance, for his approval. Delivery delays will not allow the buyer to neither cancel the order nor to apply any penalty nor indemnifications for it, except for the case that it has been specifically agreed in advance.

5. Orders

ZALUX, S.A., can unilaterally annul current orders, if the circumstances of a main force that impede their completion should occur. Understood as circumstances of a main force: industrial disputes, labour disruptions, shortage of raw materials, etc. The buyer cannot annul orders for specially made materials without our written agreement. In case of acceptance on our part the expenses incurred up to the moment of cancellation will be charged to the buyer.

6. Packaging

The products are sold in their original cardboard package. Under certain circumstances or the buyer indicates to us to use another package, it will be charged to the buyer at its cost price.

7. Transport

With the delivery of the merchandise to the transport agency the delivery is considered to have been correctly made. The risks of transport of the consignment of our products are on the buyers' account. They can only reclaim from the transport agency for the damages incurred during transport. We will with the utmost pleasure collaborate and support their reclamation with details, etc.

8. Measurements

The measurements are given in millimetres in the descriptions of the models. We reserve the right to introduce small deviations in the measurements as well as modifications due to improvements to the models. The price would be susceptible to variation in this case.

General sale conditions

9. Reclamations

Reclamations relative to numerous faults and defects will only be valid if the proper reclamation has been sent within the seven days as from the reception of the merchandise. If the reclamation is founded and the merchandise is in its original state, the corresponding acceptance will be sent.

10. Return of material

Return of material will not be accepted for reasons of mistaken instructions, shapes, quantities or material to be repaired, if we have not previously given our written authorisation. Those returns must be sent DDP ZALUX and 30% demerit of the original value will be applied. We do not accept the return of specially made products.

11. Property rights

In all cases and even against a third party, ZALUX, S.A., conserves full ownership of all the supplied materials, in the case that the agreed payment has not been settled.

12. Patent rights

All the models in this catalogue are protected by law. Legal action with right to redemption will be taken against anyone making imitations.

13. Reprints

Total or partial reproduction of this catalogue is forbidden without the corresponding written authorisation of ZALUX, S.A.

14. Payment

The form of payment will be established at the time of making a firm order for the merchandise, in accordance with the usual standards in ZALUX, S.A.

15. Jurisdiction

For any question that could arise in the completion or interpretation of these general rules, the contracting parties, with expressly renouncing any local law code that could correspond to them, will be submitted expressly to the Magistrate Law Courts of Zaragoza.

16. Modifications

ZALUX, S.A. in its continuous improvement process, reserves the right to modify its technical specifications without any previous notice.

The buyer is responsible that the product purchased in components, once fully wired, meets the requirements of the respective country.



ZALUX, S.A.
Avda. Manuel Rodríguez Ayuso, 114
Centro Empresarial Miralbueno
Planta 1ª – Local P2.
E-50012 Zaragoza, Spain
Tel.: +34 976 462 200
info@zalux.com

www.zalux.com



Catàlegue Luminaire components 2020.3