









iHF 3D

COM1 - black
 EAN 4007841 066215
 Article number 066215



		2000 W							Teach
intelligent high frequency sensor 160°	3 zones scalable 3 x 1-7m, max. 7 m	2000 W max. (LED-ready)	IP54	2 - 2000 lux	5 sec - 60 min (via App)	manual override 4h	connectable via bluetooth	Ideal 2 m	Teach mode

Function description

Makes all the difference outside. Precisely where you want it to. iHF 3D motion detector, ideal for facades, carports, parking areas and patios. 160° iHF-sensor with 7 m reach, 3D aerial technology, identifies and distinguishes between moving objects, no inadvertent triggering any more by small animals, very low or high temperatures. Detects everything equally well whichever direction it is approached from. Easy to adjust and interconnect by app and Bluetooth.

Technical specifications

Type	Motion detectors
Dimensions (L x W x H)	120 x 117 x 120 mm
Mains power supply	220 – 240 V / 50 – 60 Hz
Sensor Technology	iHF (intelligent high-frequency technology)
Application, place	Outdoors
Installation site	wall
Installation	Surface wiring
Mounting height	1,80 – 2,00 m
Reach, radial	r = 7 m (68 m ²)
Reach, tangential	r = 7 m (68 m ²)
Reach, detail	Detection zone adjustable on 3 axes
HF-system	5,8 GHz
Detection angle	160 °
Angle of aperture	100 °
Optimum mounting height	1,8 m
Mechanical scalability	No
Sneak-by guard	Yes
Capability of masking out individual segments	Yes
Electronic scalability	Yes

Twilight setting TEACH	Yes
Twilight setting	2 – 2000 lx
Time setting	5 s – 60 Min.
Switching output 1, resistive	2000 W
Constant-lighting control	No
Basic light level function	No
Functions	Normal / test mode, Manual ON / ON-OFF
Settings via	Potentiometers, Bluetooth
Interconnection	Yes
Type of interconnection	Master/master
IP-rating	IP54
Material	Plastic
Ambient temperature	-20 – 50 °C
Application, room	outdoors, front door, all round the building, terrace / balcony, courtyard & driveway
Colour	black
Colour, RAL	9005
Manufacturer's Warranty	5 years
Version	COM1 - black
PU1, EAN	4007841066215

iHF 3D

COM1 - black

EAN 4007841 066215

Article number 066215

Detection Zone

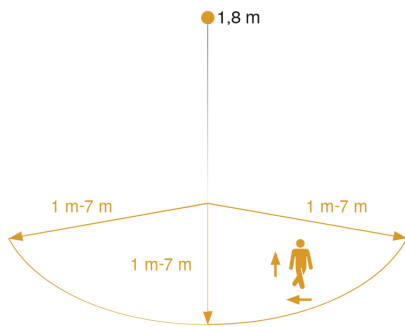

Mögliche Montagehöhe: 1,80 m – 2,00 m

Orange: radial und tangential

3 skalierbare Achsen

Dimension Drawing

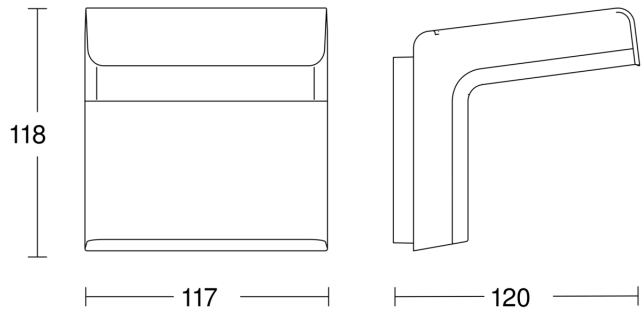

Master circuit diagram

