

## DALI RGB LED Dimmer CV

### Datasheet Control Gear

RGB LED Dimmer (CV, DT8)



Art. Nr. 89453837 (4A)

Art. Nr. 86458514 (8A)

Art. Nr. 89453839 (10A)

Art. Nr. 89453842 (16A)

# DALI RGB LED Dimmer CV Control Gear

## Overview

- DALI LED-Dimmer for RGB colour control
- suitable for constant voltage LED-modules
- **Operating Mode DT8:** one DALI-address for the independent control of light level and colour (DALI DT8, Type RGBWAF)
- **Operating Mode Colour&Dim:** control by 2 DALI-addresses, one for adjusting the light level and one for adjusting the colour
- **SwitchDim2:** 2 switch-inputs offer control of light level and colour without DALI
- dimming range 0.1%-100%
- adjustable PWM-frequency (122Hz/244Hz/488Hz/976Hz)
- compact types for integration in luminaires or remote ceiling
- supply voltage 12V to 48V DC
- type dependent max. input currents of 4A, 8A, 10A or 16A
- the maximum input current can be distributed on the channels at will
- low standby power consumption
- high efficiency
- configuration via PC-software DALI-Cockpit and DALI USB-interface
- user-friendly factory default settings

## Specification, Characteristics

type	DALI RGB LED Dimmer CV			
article number	89453837	86458514	89453839	89453842
<b>electrical data:</b>				
supply voltage	12VDC-48VDC			
maximum input current linmax	4A	8A	10A	16A
control input	DALI SwitchDim2 (mains voltage)			
current consumption DALI	2mA			
number of DALI-addresses	operating mode DT8: 1 operating mode Colour&Dim: 2			
standby power consumption (12V)	~ 120mW			
<b>technical data:</b>				
power on behaviour	configurable: 0%-100% or last value			
ambient temperature	-20°C to +60°C			
expected lifetime (at Tc<=75°C)	>100000h			
protection class	IP20			
max. connecting wire cross section	1.5 mm <sup>2</sup>	2.5 mm <sup>2</sup> / DALI &SwDim: 1.5 mm <sup>2</sup>		
dimensions (LxWxH)	59x33x15 mm	120x30x22 mm		
housing/mounting	back box	remote ceiling		

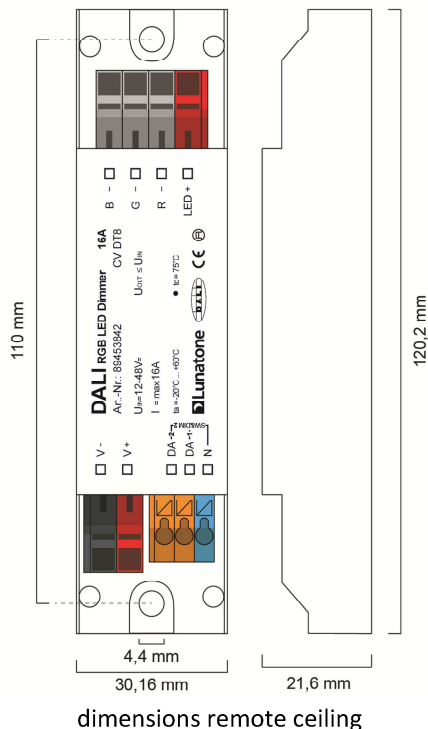

dimensions remote ceiling

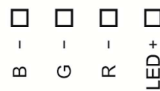

connection plan remote ceiling

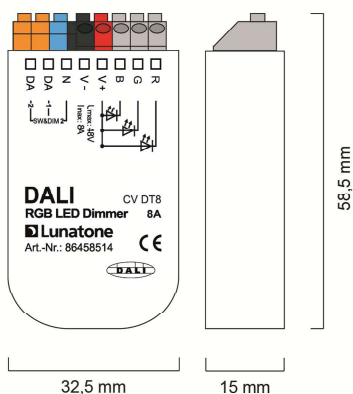

dimensions back box

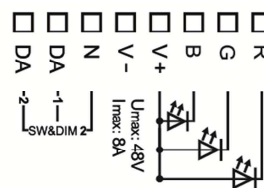

connection plan back box

RECOMMENDATION: Care should be taken on keeping cable lengths between DC power supply and dimmer as well as between dimmer and luminaires (Led-Strings) as short as possible. This kind of installation will minimize the influence of voltage drops.

DALI:

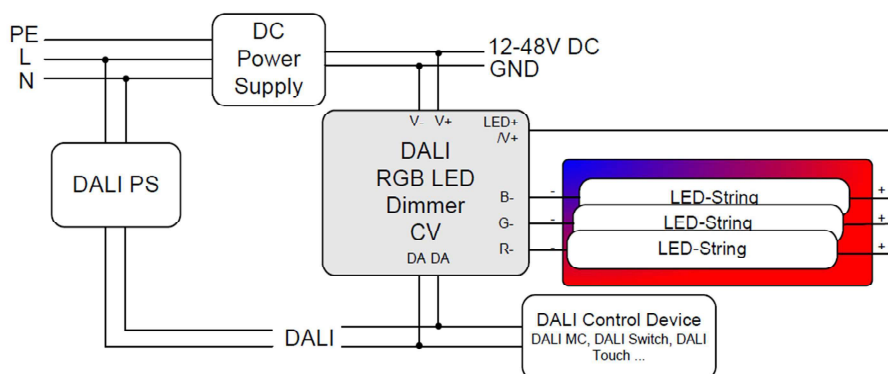

SwitchDim2:

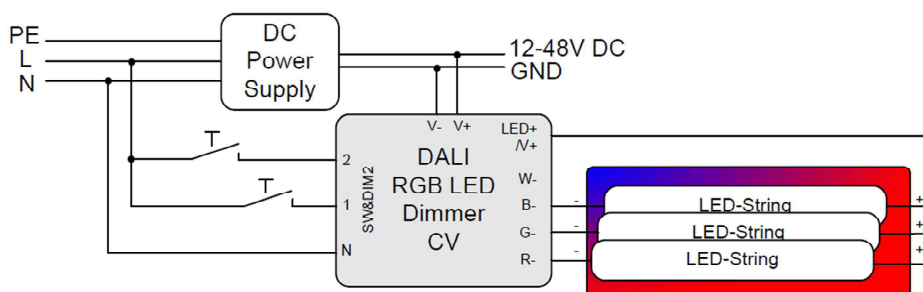

## Operating Modes

The device offers several operating modes:

### DT8 (factory default)

In this operating mode one DALI-address for the independent control of light level and colour is used (Device Type 8 RGBWAF).

Alternatively the device can be controlled using 2 switch-inputs for mains voltage (SwitchDim2):

SwD1: light level

- short press: On/Off
- long press: dimming

SwD2: colour

- long press: change colour

### Colour&Dim

This operating mode is suitable for operating RGB—luminaires. Two DALI-addresses are

used, the first to control the light level and the second for changing the distribution on the output channels (e.g. for colour adjustments).

The Colour&Dim mode allows colour adjustments without affecting the level and vice versa. For each channel only DALI-standard commands like dim up/down but also DAP are used. Thus the device can be used with all common controls and gateways (e.g. KNX). The Colour&Dim mode provides an alternative to the DT8-RGBWAF mode.

Can be operated via DALI or SwitchDim2:

DALI-address 1, SwD1: light level

DALI-address 2, SwD2: colour

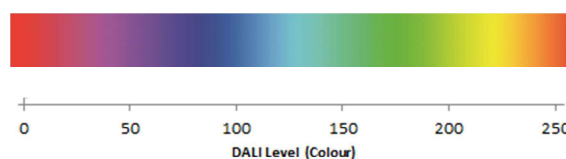

### Selection of operating mode

With the help of the PC-software tool DALI-Cockpit the operating mode can be easily set on the general settings page.

Operating mode DT8-RGBWAF:

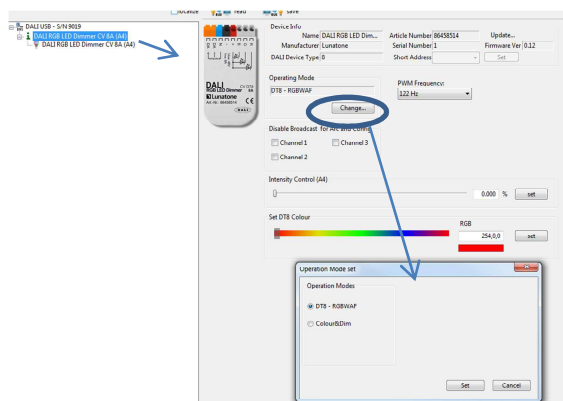

In addition, on the same page the PWM-frequency can be selected and basic control elements for testing each operating modes are available (slider for level and colour in the operating modes DT8 and Colour&Dim). Furthermore the broadcast control can be deactivated for each channel individually.

Operating mode Colour&Dim:

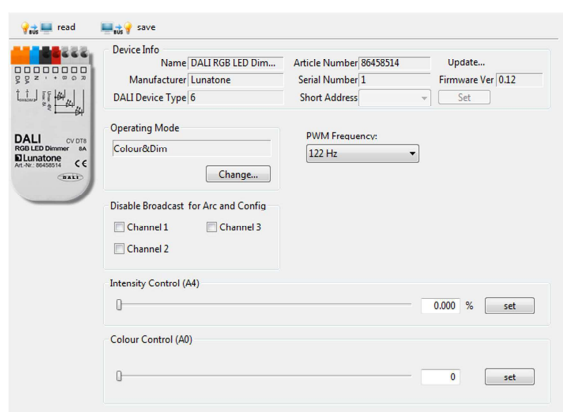

Switching between operating modes can also be done with the help of the DALI-command SET OPERATING MODE (IEC 62386-102 Ed.2). When changing the operating mode the number of used DALI-addresses can change as well and this requires a new addressing procedure. In the DALI-Cockpit this address assignment is performed automatically.

Operating Mode:

number	operating mode
0x0	DT8 (factory default)
0x92	DT8
0x93	Colour&Dim

### Additional Settings

Besides the settings on the general page each channel can be selected separately in the component tree for individual configuration.

Component Tree:

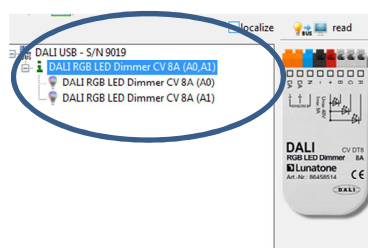

Settings in the operating mode DT8-RGBWAF (displayed parameters are the factory default values)

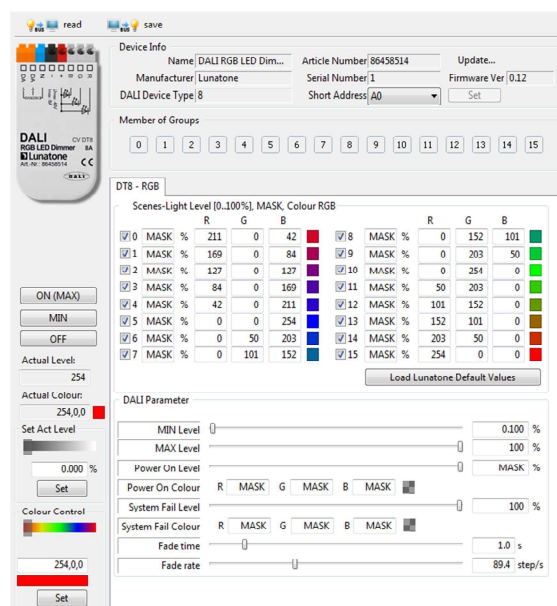

Settings for each channel in the operating mode Colour&Dim:

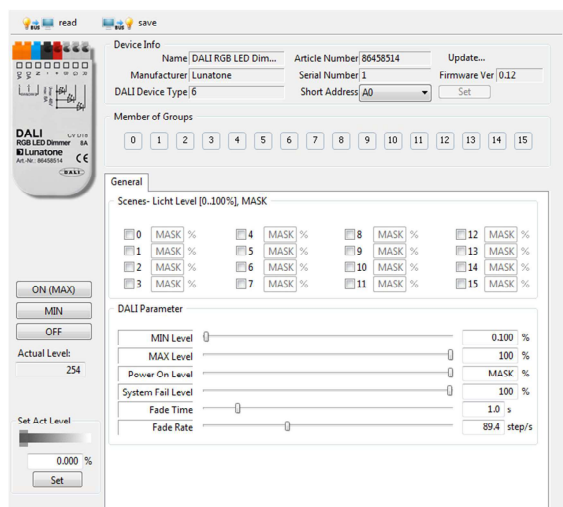

For each address the group membership can be set as well as scene values and DALI-parameters. In Colour&Dim operating mode, all values assigned to channel 2 are representing colours.

### Factory Default Settings

Before the initial addressing is performed, the device can already be controlled by a group address.

Summary of the factory default settings (delivery state):

Operating mode	DT8
SwitchDim2	SwD1: level SwD2: colour
Min Level	0.1%
PowerOn Level	MASK (last value)
Fade Time	2 (1s)
Fade Rate	5 (89.4 steps/s)
PWM-frequency	Auto
Groups before initial addressing:	G0 (or G0 and G1 in operating mode Colour&Dim)

Predefined Scene Values:

		R	G	B
<input checked="" type="checkbox"/> 0	MASK %	211	0	42
<input checked="" type="checkbox"/> 1	MASK %	169	0	84
<input checked="" type="checkbox"/> 2	MASK %	127	0	127
<input checked="" type="checkbox"/> 3	MASK %	84	0	169
<input checked="" type="checkbox"/> 4	MASK %	42	0	211
<input checked="" type="checkbox"/> 5	MASK %	0	0	254
<input checked="" type="checkbox"/> 6	MASK %	0	50	203
<input checked="" type="checkbox"/> 7	MASK %	0	101	152
<input checked="" type="checkbox"/> 8	MASK %	0	152	101
<input checked="" type="checkbox"/> 9	MASK %	0	203	50
<input checked="" type="checkbox"/> 10	MASK %	0	254	0
<input checked="" type="checkbox"/> 11	MASK %	50	203	0
<input checked="" type="checkbox"/> 12	MASK %	101	152	0
<input checked="" type="checkbox"/> 13	MASK %	152	101	0
<input checked="" type="checkbox"/> 14	MASK %	203	50	0
<input checked="" type="checkbox"/> 15	MASK %	254	0	0

### Purchase Order Information

**Art.Nr. 89453837:** RGB LED Dimmer, CV, input current 4A, 12V-48V DC, SwitchDim2, back box

**Art.Nr. 86458514:** RGB LED Dimmer, CV, input current 8A, 12V-48V DC, SwitchDim2, back box

**Art.Nr. 89453839:** RGB LED Dimmer, CV, input current 10A, 12V-48V DC, SwitchDim2, remote ceiling & integration in luminaires

**Art.Nr. 89453842:** RGB LED Dimmer, CV, input current 16A, 12V-48V DC, SwitchDim2, remote ceiling & integration in luminaires

### Additional Information and Equipment

DALI-Cockpit – free configuration tool from Lunatone for DALI systems

<http://lunatone.at/en/downloads/Lunatone-DALI-Cockpit.zip>

Lunatone DALI products

<http://www.lunatone.at/en/>

Lunatone datasheets and manuals

<http://lunatone.at/en/downloads/>

## Contact

Technical Support: [support@lunatone.com](mailto:support@lunatone.com)

Requests: [sales@lunatone.com](mailto:sales@lunatone.com)

[www.lunatone.com](http://www.lunatone.com)

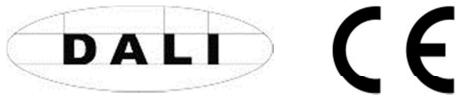

## Disclaimer

Subject to change. Information provided without guarantee.  
The datasheet refers to the current delivery.

The compatibility with other devices must be tested in advance  
to the installation.