

# 2.10

## WATEX

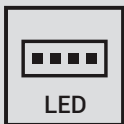

LED

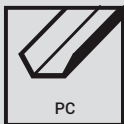

PC



PCO



RAB/BAR/RAB

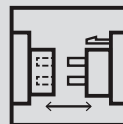

ZONA  
2-22  
«nR»

**APLICACIONES INDICADAS** / SUITABLE APPLICATIONS / APPLICATIONS APPROPRIÉES

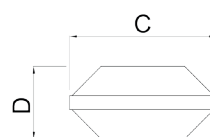
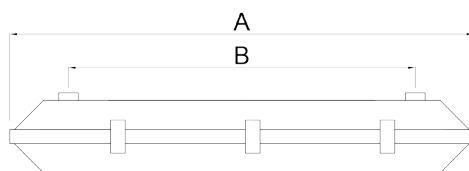
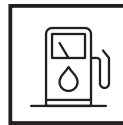

IT - DE



IP66

IK08



2014/34/EU



II 3GD  
Ex nR IIC T5 Gc  
Ex tb IIIC T100°C Dc



**1 MODULO LED / 1 LED MODULE / MODULE LED**

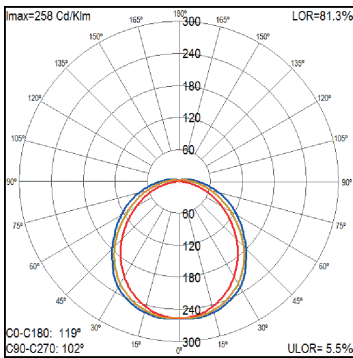

Ref.	Tamaño Size Dimension	Potencia Power Puissance	Emisión bruta Gross output Flux de la source	Emisión neta Net output Flux sortant	Tª color Tª colour Tª couleur	A	B	C	D
		(W)	(Lm)	(Lm)	(°K)	(mm)	(mm)	(mm)	
EW113	600	13	1490	1210	3000	664	260	100	110
EW114	600	13	1550	1259	4000	664	260	100	110
EW123	600	16	2560	2079	3000	664	260	100	110
EW124	600	16	2670	2168	4000	664	260	100	110
EW213	1200	24	2980	2420	3000	1274	870	100	110
EW214	1200	24	3200	2598	4000	1274	870	100	110
EW223	1200	32	5120	4157	3000	1274	870	100	110
EW224	1200	32	5340	4336	4000	1274	870	100	110
EW313	1500	29	3720	3021	3000	1575	650	100	110
EW314	1500	29	4000	3248	4000	1575	650	100	110
EW323	1500	40	6310	5124	3000	1575	650	100	110
EW324	1500	40	6700	5440	4000	1575	650	100	110

# 2.10

## WATEX

### 2 MODULOS LED / 2 LED MODULES / 2 MODULES LED

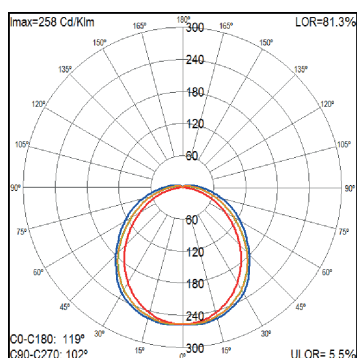









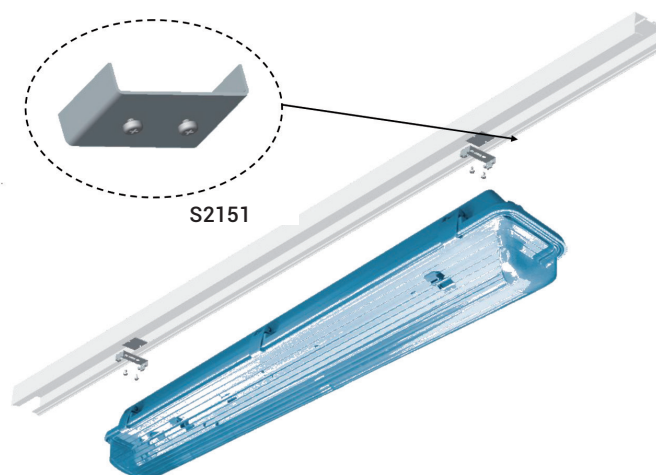



















































Ref.	Tamaño Size Dimension	Potencia Power Puissance	Emisión bruta Gross output Flux de la source	Emisión neta Net output Flux sortant	Tª color Tª colour Tª couleur	A	B	C	D
	(mm)	(W)	(Lm)	(Lm)	(°K)	(mm)	(mm)	(mm)	
EY113	600	24	2980	2420	3000	664	260	160	110
EY114	600	24	3200	2598	4000	664	260	160	110
EY123	600	32	5120	4157	3000	664	260	160	110
EY124	600	32	5340	4336	4000	664	260	160	110
EY213	1200	48	5960	4840	3000	1274	870	160	110
EY214	1200	48	6400	5197	4000	1274	870	160	110
EY223	1200	64	10240	8315	3000	1274	870	160	110
EY224	1200	64	10680	8672	4000	1274	870	160	110
EY313	1500	58	7440	6041	3000	1575	650	160	110
EY314	1500	58	8000	6496	4000	1575	650	160	110
EY323	1500	80	12620	10247	3000	1575	650	160	110
EY324	1500	80	13400	10881	4000	1575	650	160	110

### ACCESORIOS WATEX / WATEX ACCESORIES / ACCESSOIRES WATEX

1-10  
DALI

EMERGENCY  
1h / 3h



	Cuerpo luminaria tubo policarbonato Polycarbonate luminaire body Corps du luminaire tube polycarbonate		Cuerpo extrusion Aluminum body Corps aluminium		Rango de temperaturas Temperatures range Tranche de temperatures
	Cuerpo luminaria metacrilato Methacrylate luminaire body Corps du luminaire méthacrylate		Cuerpo Acero Prelacado Pre-lacquered steel body Corps en acier prélaqué		Ensayo hilo Glow wire test Essais fil incandescent
	Cuerpo luminaria vidrio borosilicato Glass borosilicate luminaire body Corps du luminaire verre borosilicate		Cuerpo Aluminio Prelacado Pre-lacquered aluminum body Corps en aluminium prélaqué		Alto factor High Factor Hautes temperatures
	Cuerpo luminaria ABS ABS luminaire body Corps du luminaire ABS		Cuerpo ABS ABS body Corp ABS		Conector rápido Quick Connector Connecteur rapide
	Cuerpo luminaria poliestireno Polystyrene luminaire body Corps du luminaire polystyrène		Difusor Policarbonato Polycarbonate Diffuser Diffuseur Polycarbonate		Entrada cablesroca M25 (2e) M25 Cable entry (2e) Entrée de câbles a vis M25 (2e)
	Cuerpo aluminio Extrusion Aluminum Body Corps extrusión aluminium		Difusor Policarbonato Opal Opal Polycarbonate Diffuser		Regulación de flujo Dimmable equipment Ballast gradable
	Cuerpo hierro Iron body Corps fer		Difusor Poliestireno Polystyrene Diffuser Diffuseur Polystyrène		Módulo LED LED Module Modules LED
	Tapas Aluminio pintado Painted Aluminum end caps Embouts aluminium peint		Difusor PC/ACRIL PC/ACRIL Diffuser Diffuseur PC/ACRIL		Tubo LED LED Tube Tube LED
	Tapa acero INOX Stainless Steel 304 end caps Embouts INOX 304		Lamas ABS ABS louvers Lames ABS		Tubo fluorescencia Fluorescent Tube Tube Fluorescent
	Tapa acero INOX Stainless Steel 316 end caps		Lamas ABS - PC ABS - PC louvers Lames ABS - PC		Tubo LED o Tubo fluorescente LED Tube or fluorescent tube Tube LED ou Tube fluorescent
	Tapas ABS ABS Plastic end caps Embouts PLASTIQUE ABS		Abrazaderas acero cincado Galvanized Steel Clamps Fixations acier zingué		Fuente de luz Light source Source de lumière
	Tapas Policarbonato PC Plastic end caps Embouts PLASTIQUE PC		Abrazaderas acero inox Stainless Steel Clamps Fixations INOX		Fuente de luz Light source Source de lumière
	Tapas Plástico Metalizado Metalized Plastic end caps Embouts PLASTIQUE CHROMÉ		Abrazaderas cierre rápido Quick opening stainless steel Fixations INOX ouverture à grenouillère		Fuente de luz Light source Source de lumière
	Tapas Zamak Niquelado Nickel-plated ZAMAK end caps Embouts ZAMAK NICKELÉ		Abrazaderas PC antivandálica Vandalism PC Clamps Fixations INOX ouverture à grenouillère		Zona ATEX EX Area ATEX Zone
	Tapas acero niquelado Nickel-plated steel end caps Embouts Acier Nickelé		Abrazaderas ABS ABS Clamps Fixations PMMA antivandalisme		Sistema de emergencia Emergy System Sisteme d'emergencia
	Aluminio Anodizado Anodized aluminum Aluminium anodisé		Aro ABS ABS Ring Fixations ABS		Grupo de riesgo fotobiológico Photobiological risk group Group de risque fotobiologique
	Reflector Aluminio brillo Reflector Aluminum Gloss Réflecteur Aluminium brillant		Abrazaderas techo o pared Ceiling or wall Clamps Fixations murs et parois		Índice MacAdam MacAdam Ellipse Taux MacAdam
	Reflector chapa lacada blanca White lacquered steel Reflector Réflecteur tôle laquée blanc		Prensaestopa Cable Gland Presse étoupes		Índice de deslumbramiento unificado Unify glare rating Taux d'éblouissement
	Reflector acero lacado blanco White Lacquered Steel Reflector Réflecteur acier laqué blanc		Empotrable para lámpara Embedded for lamps Encastrable pour lamp		Índice cromático Chromatic Index Taux chromatique
	Reflector acero galvanizado Galvanized Steel Reflector Réflecteur acier galvanisé		Brida suspensión perforación 18mm Clamps suspension borehole 18 mm Fixation avec suspension perforation 18 mm		Vida útil Useful life Durée de vie