

## DALI 3Ch LED Dimmer CV

### Datasheet Control Gear



3-channel LED Dimmer (CV, DT6)

Art. Nr. 89453828 (4A)

Art. Nr. 89453834 (8A)

Art. Nr. 86459571 (10A)

Art. Nr. 89453831 (16A)

# DALI 3Ch LED Dimmer CV Control Gear

## Overview

- 3 channel DALI LED-Dimmer
- suitable for constant voltage LED-modules
- **Operating Mode DT6:** individual channel control via 3 DALI addresses
- **Operating Mode Colour&Dim:** control by 2 DALI-addresses, one for adjusting the light level and one for adjusting the colour
- **SwitchDim2:** 2 switch-inputs offer control of light level and colour without DALI
- dimming range 0.1%-100%
- adjustable PWM-frequency (122Hz/244Hz/488Hz/976Hz)
- compact types for integration in luminaires and remote ceiling
- supply voltage 12V to 48V DC
- type dependent max. input currents of 4A, 8A, 10A or 16A
- the maximum input current can be distributed on the channels at will
- low standby power consumption
- high efficiency
- configuration via PC-software DALI-Cockpit and DALI USB-interface
- user-friendly factory default settings

## Specification, Characteristics

type	DALI 3Ch LED Dimmer			
article number	89453828	89453834	89459571	89453831
<b>electrical data:</b>				
supply voltage	12VDC-48VDC			
maximum input current I <sub>inmax</sub>	4A	8A	10A	16A
control input	DALI SwitchDim2 (mains voltage)			
current consumption DALI	2mA			
number of DALI-addresses	operating mode DT6: 3 operating mode Colour&Dim: 2			
standby power consumption (12V)	~ 120mW			
<b>technical data:</b>				
power on behaviour	configurable: 0%-100% or last value			
ambient temperature	-20°C to +60°C			
expected lifetime (at T <sub>c</sub> ≤75°C)	>100000h			
protection class	IP20			
max. connecting wire cross section	1.5 mm <sup>2</sup>		2.5 mm <sup>2</sup> / DALI&SwD: 1.5 mm <sup>2</sup>	
dimensions (LxWxH)	59x33x15 mm		120x30x22 mm	
housing/mounting	back box		remote ceiling	

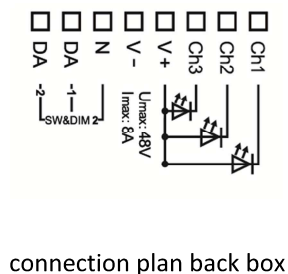
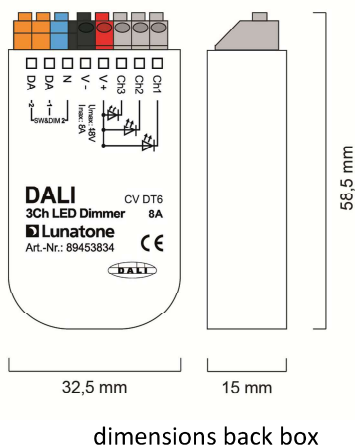
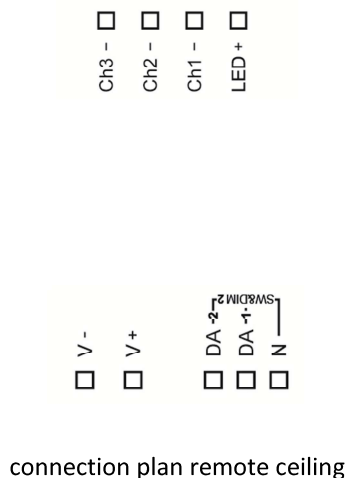
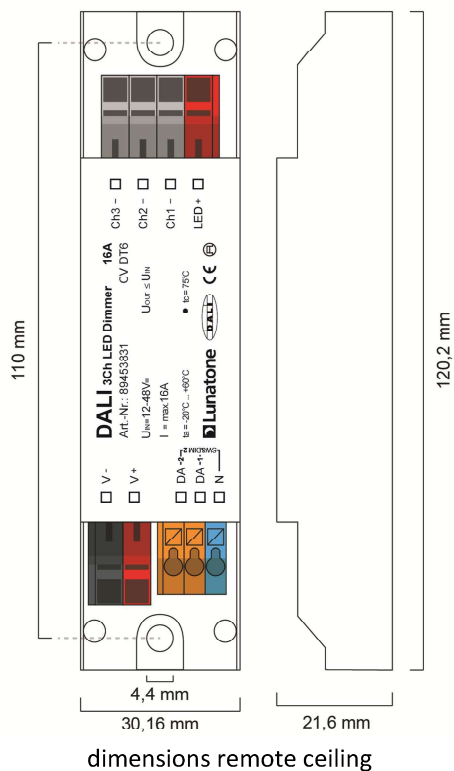

**RECOMMENDATION:** Care should be taken on keeping cable lengths between DC power supply and dimmer as well as between dimmer and luminaires (Led-Strings) as short as possible. This kind of installation will minimize the influence of voltage drops.

DALI:

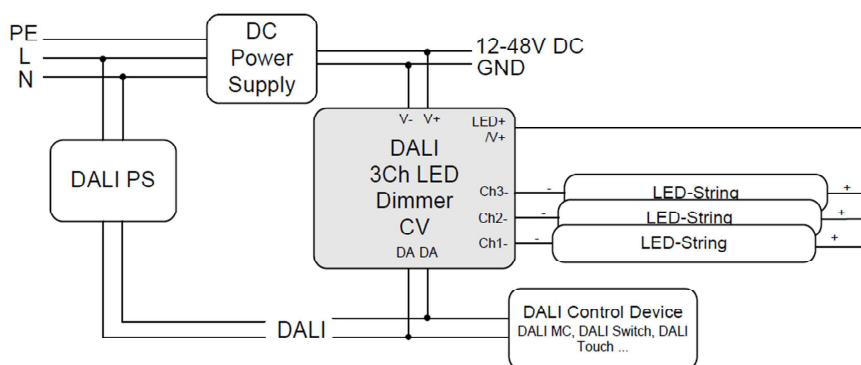

SwitchDim2:

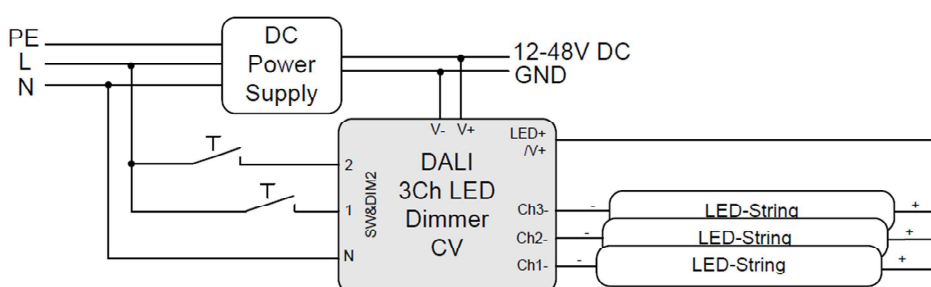

## Operating Modes

The device offers several operating modes:

### DT6 (factory default)

In this operating mode each channel can be controlled by its own DALI address (Device Type 6).

Alternatively the device can be controlled using 2 switch-inputs for mains voltage (SwitchDim2):

SwD1: light level

short press: On/Off

long press: dimming

SwD2: scene selector (short press)

### Colour&Dim

This operating mode is suitable for operating RGB—luminaires. Two DALI-addresses are used, the first to control the light level and the second for changing the distribution on the output channels (e.g. for colour adjustments).

The Colour&Dim mode allows colour adjustments without affecting the light level and vice versa. For each channel only DALI-standard commands like dim up/down but also DAP are used. Thus the device can be used with all common controls and gateways (e.g. KNX). The Colour&Dim mode provides an alternative to the DT8-RGBWAF mode.

Can be operated via DALI or SwitchDim2:

DALI-address 1, SwD1: light level

DALI-address 2, SwD2: colour

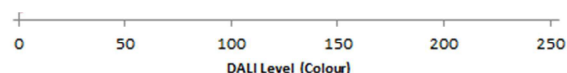

**Selection of operating mode**

With the help of the PC-software tool DALI-Cockpit the operating mode can be easily set on the general settings page.

Operating mode DT6:

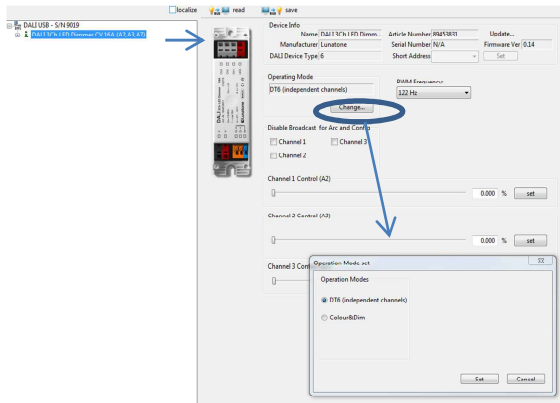

In addition, on the same page the PWM-frequency can be selected and basic control elements for testing each operating modes are available (3 sliders for the level of each channel in operating mode DT6 and slider for level and colour in the operating mode Colour&Dim). Furthermore the broadcast control can be deactivated for each channel individually.

Operating mode Colour&Dim:

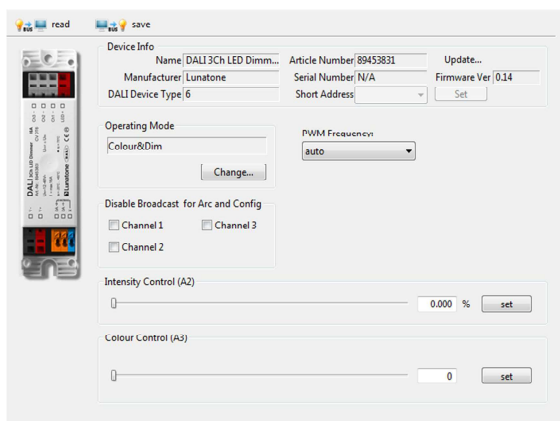

Switching between operating modes can also be done with the help of the DALI-command SET OPERATING MODE (IEC 62386-102 Ed.2). When changing the operating mode the number of used DALI-addresses can change as well and this requires a new addressing

procedure. In the DALI-Cockpit this address assignment is performed automatically.

Operating Mode:

Number	Operating Mode
0	DT6 (factory default)
0x90	DT6
0x93	Colour&Dim

**Additional Settings**

Besides the settings on the general page each channel can be selected separately in the component tree for individual configuration.

Component Tree:

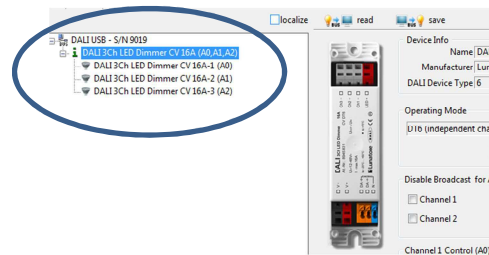

Settings for each channel (operating mode DT6 and Colour&Dim):

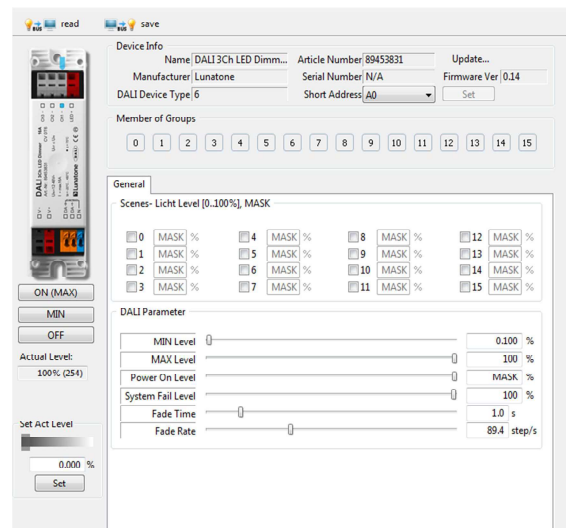

For each address the group membership can be set as well as scene values and DALI-parameters. In Colour&Dim operating mode, all values assigned to channel 2 are representing colours.

## Factory Default Settings

Before the initial addressing is performed, the device can already be controlled by a group address.

Summary of the factory default settings (delivery state):

Operating mode	DT6
SwitchDim2	SwD1: light level SwD2: scene selector
Min Level	0.1%
PowerOn Level	MASK (last value)
Fade Time	2 (1s)
Fade Rate	5 (89.4 steps/s)
PWM-frequency	auto
Groups before initial addressing:	G0 – channel1 G1 – channel2 G2 – channel3

## Purchase Order Information

**Art.Nr. 89453828:** 3-channel LED Dimmer, CV, max. input current 4A, 12V-48V DC, back box

**Art.Nr. 89453834:** 3-channel LED Dimmer, CV, max. input current 8A, 12V-48V DC, back box

**Art.Nr. 86459571:** 3-channel LED Dimmer, CV, max. input current 10A, 12V-48V DC, SwitchDim2, remote ceiling & integration in luminaires

**Art.Nr. 89453831:** 3-channel LED Dimmer, CV, max. input current 16A, 12V-48V DC, SwitchDim2, remote ceiling & integration in luminaires

## Additional Information and Equipment

DALI-Cockpit – free configuration tool from Lunatone for DALI systems

<http://lunatone.at/en/downloads/Lunatone-DALI-Cockpit.zip>

Lunatone DALI products

<http://www.lunatone.at/en/>

Lunatone datasheets and manuals

<http://lunatone.at/en/downloads/>

## Contact

Technical Support: [support@lunatone.com](mailto:support@lunatone.com)

Requests: [sales@lunatone.com](mailto:sales@lunatone.com)

[www.lunatone.com](http://www.lunatone.com)



## Disclaimer

Subject to change. Information provided without guarantee. The datasheet refers to the current delivery.

The compatibility with other devices must be tested in advance to the installation.