

PRODUCT DATASHEET

PANEL VAL 600 36 W 3000 K WT

PANEL VALUE 600 | Square recessed panel luminaires, 600 x 600 mm

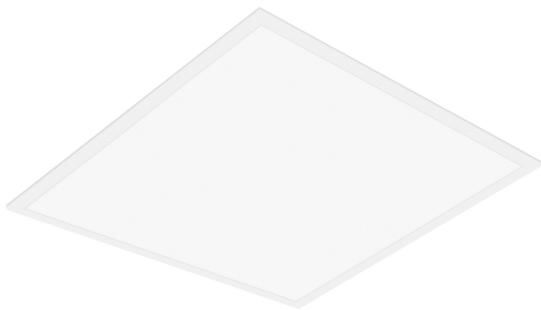

Areas of application

- Direct replacement for luminaires with fluorescent lamps
- Offices, conference rooms
- Reception areas, foyers, corridors, elevators
- Suitable for recessed ceiling systems with grid size of 600 x 600 mm

Product benefits

- Value for money luminaire
- Low flicker light thanks to special electronic control gear
- Energy savings thanks to system efficacy of up to 100 lm/W
- External driver for extended flexibility and easy installation
- Versions with DALI ECG available

Product features

- Lifetime (L70/B50): up to 50,000 h (at 25 °C)
- Extruded aluminum frame
- Polystyrene diffuser



TECHNICAL DATA

Electrical data

Nominal wattage	36.00 W
Nominal voltage	220...240 V
Mains frequency	50...60 Hz
Nominal current	170 mA
Inrush current	10.4 A
Inrush current time T_{h50}	200 μ s
Max. no. of lum. on circuit break. B16 A	19
Max. no. of lum. on circuit break. C10 A	19
Max. no. of lum. on circuit break. C16 A	30
Power factor λ	> 0.90
Total harmonic distortion	< 15 %
Protection class	II
Operating mode	External LED driver

Photometrical data

Luminous flux	3600 lm
Luminous efficacy	100 lm/W
Color temperature	3000 K
Light color (designation)	Warm White
Color rendering index Ra	> 80
Standard deviation of color matching	5 sdc _m
Low flicker	Yes
Flickering metric (Pst LM)	-
Stroboscope effect metric (SVM)	-
Photobiological safety group acc. to EN62778	RG0
Beam angle	120 °



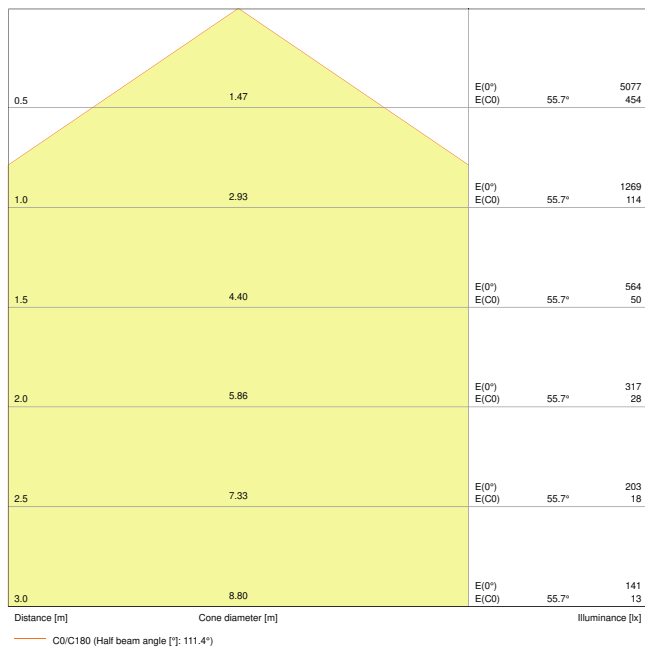

LDC typ cone

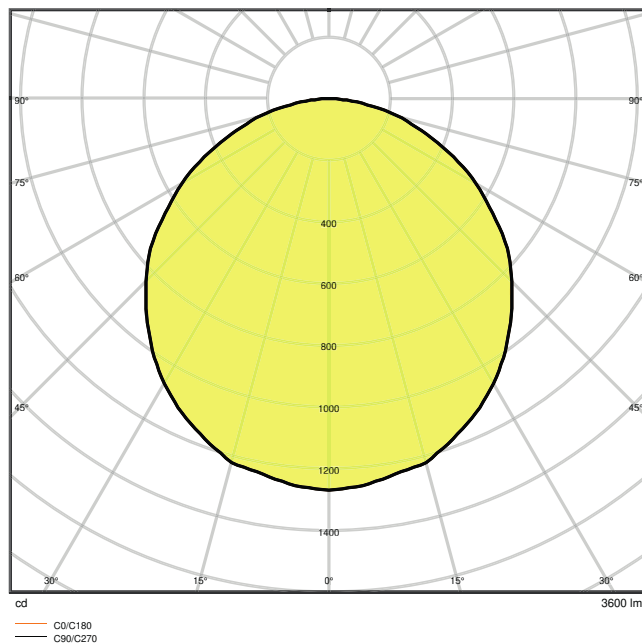

LDC typ polar

Dimensions & Weight

Length	595.00 mm
Width	595.00 mm
Height	35.00 mm
Product weight	1800.00 g

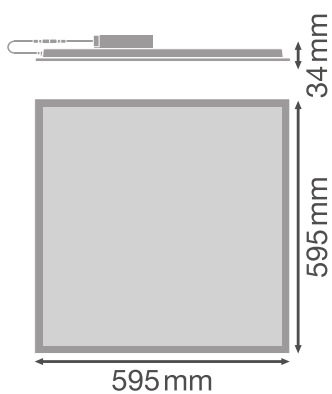

Materials & Colors

Product color	White
Housing color	White
Body material	Aluminum
Cover material	Polystyrene (PS)
Light emitting surface material	Polystyrene
Glow Wire Test according to IEC 60695-2-12	650 °C
Mercury content	0.0 mg

Application & Mounting

Ambient temperature range	-10...+45 °C
Type of connection	Screwless terminal
Type of protection	IP40
Protection class IK (shock resistance)	IK02
Dimmable	No
Mounting type	Recessed/Suspended/Surface
Mounting location	Ceiling / Wall
Application environment	Indoor
Mounting length	580 mm
Mounting width	580 mm
Mounting depth	50,0 mm
LED module replaceable	Not replaceable

Lifespan

Lifespan L70/B50 at 25 °C	50000 h
Lifespan L80/B10 at 25 °C	50000 h
Lifespan L90/B10 at 25 °C	30000 h
Number of switching cycles	25000

Control gear

ECG - Output ripple current	≤ 5 %
-----------------------------	-------

Certificates & Standards













Standards	CE / CB / EAC
Luminaire with limited surface temperature, "D sign"	No
Ball shot safe	No



EQUIPMENT / ACCESSORIES

- Accessories for several mounting options available
- External control gear included
- Security brackets included

DOWNLOAD DATA

DOWNLOAD DATA	
	User instruction
	User instruction
	Addon Technical Information
	Addon Technical Information
	Tender documents
	Declarations of conformity
	IES file (IES)
	LDT file (Eulumdat)
	R3D file (Relux 3D Model)
	M3D file (3D Model)
	ULD file (DIALux)
	UGR file (UGR table)

LOGISTICAL DATA

Product code	Packaging unit (Pieces/Unit)	Dimensions (length x width x height)	Gross weight	Volume
4058075392373	Shipping box 4	667 mm x 182 mm x 634 mm	10015.00 g	76.96 dm ³



The mentioned product code describes the smallest quantity unit which can be ordered. One shipping unit can contain one or more single products. When placing an order, for the quantity please enter single or multiples of a shipping unit.

ADDITIONAL CATALOG INFORMATION

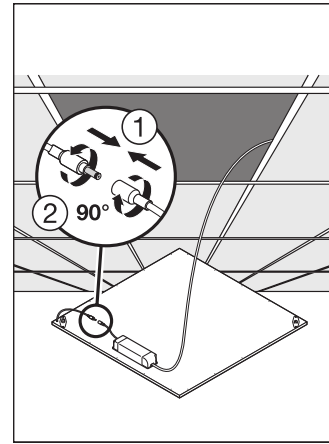
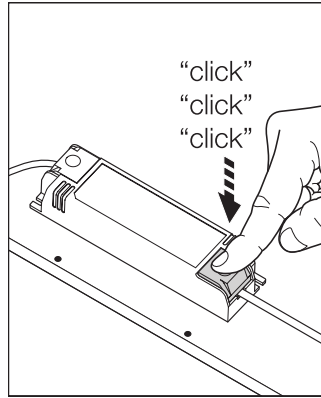
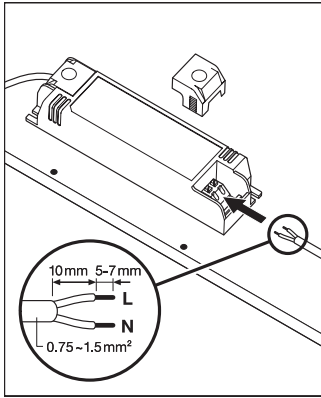

References / Links

- For Guarantee see www.ledvance.com/guarantee

DISCLAIMER

Subject to change without notice. Errors and omission excepted. Always make sure to use the most recent release.

