

PRODUCT DATASHEET

DL IP44 DN 90 4W 840 WT

DOWNLIGHT IP44 | Downlights with IP44 grade



Areas of application

- Direct replacement for luminaires with fluorescent lamps
- General illumination
- Public areas
- Stairways
- Corridors
- Shops
- Bathrooms

Product benefits

- High luminous efficacy
- Very homogenous light
- Simple installation thanks to integrated driver

Product features

- Type of protection: IP44
- Luminous efficacy: 100 lm/W



TECHNICAL DATA**Electrical data**

| | |
|--|-----------------------|
| Nominal wattage | 4.00 W |
| Nominal voltage | 220...240 V |
| Mains frequency | 50...60 Hz |
| Nominal current | 30.000 mA |
| Inrush current | 4.4 A |
| Inrush current time T_{h50} | 250 μ s |
| Max. no. of lum. on circuit break. B16 A | 373 |
| Max. no. of lum. on circuit break. C10 A | 200 |
| Max. no. of lum. on circuit break. C16 A | 320 |
| Power factor λ | 0.50 |
| Total harmonic distortion | < 80 % |
| Protection class | II |
| Operating mode | Integrated LED driver |

Photometrical data

| | |
|--|----------------------|
| Luminous flux | 400 lm |
| Luminous efficacy | 100 lm/W |
| Color temperature | 4000 K |
| Light color (designation) | Cool White |
| Color rendering index Ra | > 80 |
| Standard deviation of color matching | < 6 sdc _m |
| Low flicker | Yes |
| Photobiological safety group acc. to EN62778 | RG0 |
| Photobiological safety group acc. to EN62471 | RG0 |
| Beam angle | 100 ° |

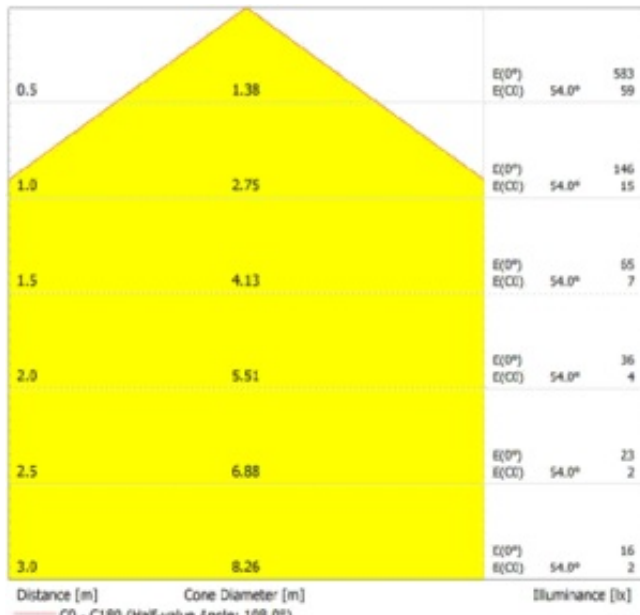

LDC typ cone

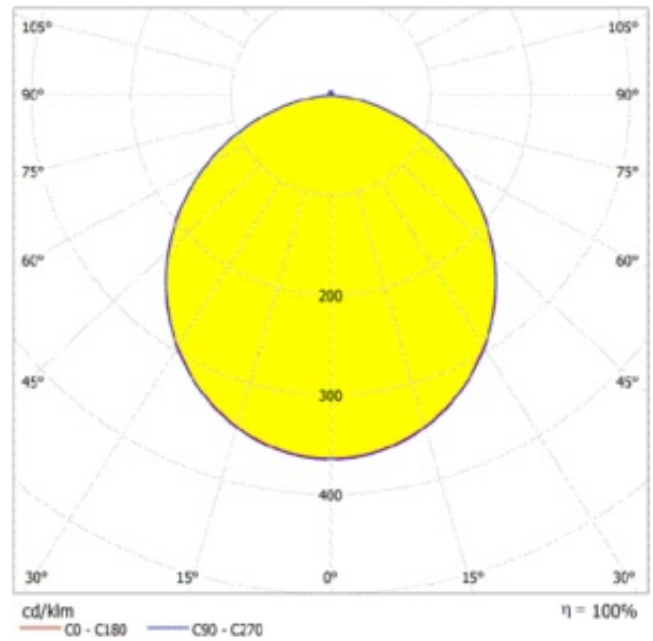

LDC typ polar

Dimensions & Weight

| | |
|----------------|----------|
| Diameter | 90.00 mm |
| Height | 42.00 mm |
| Product weight | 50.00 g |

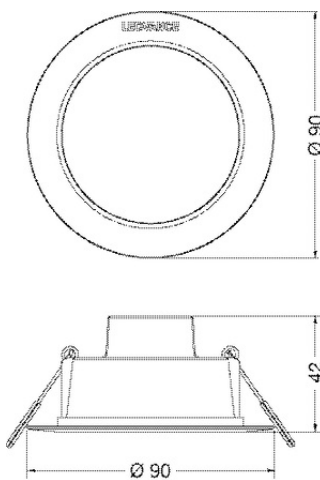

Materials & Colors

| | |
|--|--------------------|
| Product color | White |
| Housing color | White |
| Body material | Polycarbonate (PC) |
| Cover material | Polycarbonate (PC) |
| Light emitting surface material | Polycarbonate (PC) |
| Glow Wire Test according to IEC 60695-2-12 | 650 °C |
| Mercury content | 0.0 mg |

Application & Mounting

| | |
|--|-----------------|
| Ambient temperature range | -20...+40 °C |
| Temperature range at storage | -20...+80 °C |
| Type of connection | Cable, 2-pole |
| Type of protection | IP44 |
| Protection class IK (shock resistance) | IK03 |
| Dimmable | No |
| Mounting type | Recessed |
| Mounting location | Ceiling |
| Application environment | Indoor |
| Mounting diameter | 90 mm |
| Mounting depth | 40 mm |
| Adjustable | No |
| LED module replaceable | Not replaceable |
| With light source | Yes |

Lifespan

| | |
|----------------------------|---------|
| Lifespan L70/B50 at 25 °C | 20000 h |
| Lifespan L80/B10 at 25 °C | 18000 h |
| Lifespan L90/B10 at 25 °C | 15000 h |
| Number of switching cycles | 100000 |

Control gear

| | |
|-----------------------------|-------|
| Output current | 66 mA |
| ECG - Output ripple current | < 5 % |









Certificates & Standards

| | |
|--|-----------------------------|
| Standards | CE / EMC / ROHS 2.0 / REACH |
| Luminaire with limited surface temperature, "D sign" | No |
| Ball shot safe | No |

EQUIPMENT / ACCESSORIES

- Surface mounting frames available as accessories

DOWNLOAD DATA

| DOWNLOAD DATA | |
|---|-----------------------------|
|  | User instruction |
|  | Addon Technical Information |
|  | IES file (IES) |
|  | LDT file (Eulumdat) |
|  | R3D file (Relux 3D Model) |
|  | M3D file (3D Model) |
|  | UGR file (UGR table) |
|  | Packaging insert |

LOGISTICAL DATA

| Product code | Packaging unit (Pieces/Unit) | Dimensions (length x width x height) | Gross weight | Volume |
|---------------|------------------------------|--------------------------------------|--------------|----------------------|
| 4058075702882 | Folding box 1 | 95 mm x 51 mm x 95 mm | 83.00 g | 0.46 dm ³ |
| 4058075702899 | Shipping box 10 | 269 mm x 200 mm x 111 mm | 842.00 g | 5.97 dm ³ |

The mentioned product code describes the smallest quantity unit which can be ordered. One shipping unit can contain one or more single products. When placing an order, for the quantity please enter single or multiples of a shipping unit.

DISCLAIMER

Subject to change without notice. Errors and omission excepted. Always make sure to use the most recent release.