

## 35 W Dimmable two channel intelligent Colour LED driver

- 2-channel tunable white for human centric lighting
- Wide dynamic range of colour temperatures on all dimming levels
- SELV output protection for safety and flexibility in luminaire design
- Driver protection Class II
- Suitable for Class I and Class II luminaires
- Optional strain relief for independent use outside of luminaire (LC1x70-SR) and driving Class III luminaires

35 W 220 – 240 V 0 / 50 – 60 Hz

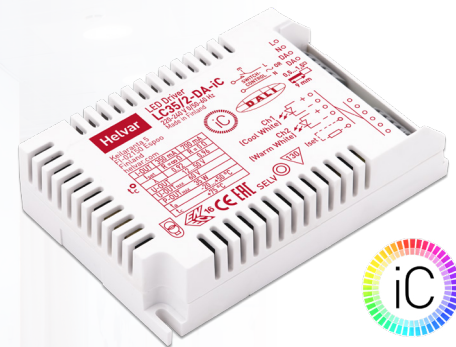

### Functional Description

- DALI type 8 compatible. One DALI address for controlling colour temperature by two output channels
- DALI colour type: Colour temperature  $T_c$
- Adjustable constant current output: 350 mA (default) to 700 mA
- Output current programmable by Helvar driver configurator tool, by DALI commands or by external resistors
- Hybrid dimming technique for high quality light. Colour temperature controllable down to 2 % minimum dimming level
- Switch-Control functionality for easy-to-use intensity and colour temperature control
- Multipurpose terminal Iset/NTC for current setting or overtemperature protection
- Full load recognition, open and short circuit protection
- Constant Light Output (CLO) (default disabled)
- Power monitoring (real time), Running hour monitor (accumulative), Energy management (accumulative)

### Mains Characteristics

Voltage range	198 VAC – 264 VAC
DC range	176 VDC - 280 VDC
starting voltage	> 190 VDC
Mains current at full load	0.17 - 0.19 A
Frequency	0 / 50 Hz – 60 Hz
Stand-by power consumption	< 0.45 W
Failure mode power consumption	< 1.5 W
THD at full power	< 15 %
Tested surge protection	1 kV L-N, 2 kV L-GND (IEC 61000-4-5)
Tested fast transient protection	4 kV (IEC 61000-4-4)

### Insulation between circuits

Mains circuit - SELV circuit	Double/reinforced insulation
DALI circuit - SELV circuit	Double/reinforced insulation
Mains circuit - DALI circuit	Basic insulation

### Load Output (SELV <60 V)

Output current ( $I_{out}$ )	350 mA (default) – 700 mA
Accuracy	± 5 %
Ripple	< 2 %*, at ≤ 120 Hz
	*] Low frequency, LED load: Cree XM-L LEDs
$U_{out}$ (max) (abnormal)	60 V

$I_{out}$	350 mA	700 mA
$P_{out}$ (max)	17.5 W	35 W
$U_{out}$	12 V – 50 V	12 V – 50 V
$\lambda$ at full load	0.92	0.96
Efficiency ( $\eta$ ) at full load	0.83	0.88

Operating window

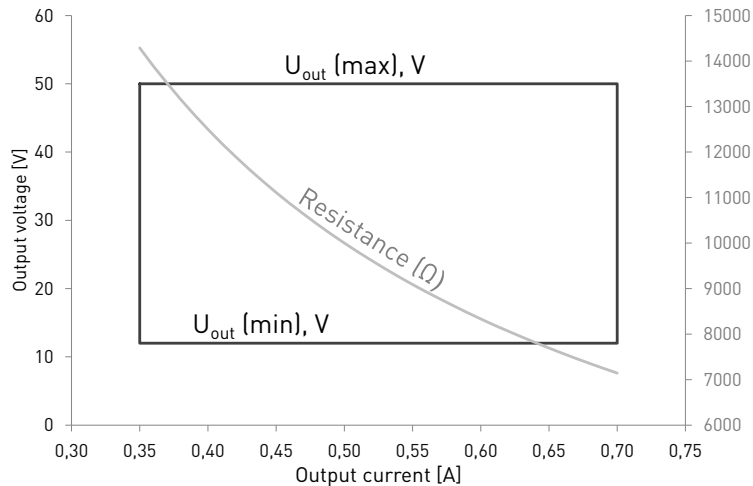

Note: Dimming between 0.2 % - 100 % per channel possible across the whole operating window

Driver performance

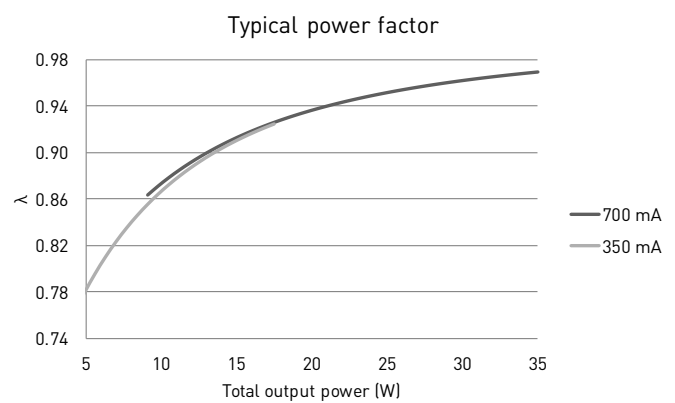
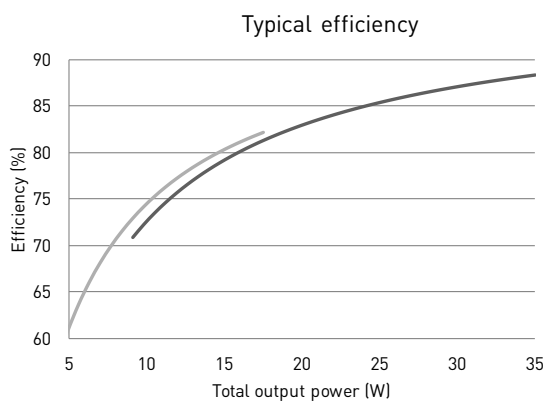

Operating Conditions and Characteristics

Highest allowed $t_c$ point temperature	75 °C
Ambient temperature range	-20 °C ... +50 °C
Storage temperature range	-40 °C ... +80 °C
Maximum relative humidity	Up to 85 %, condensation not allowed
Life time (90 % survival rate)	100 000 h, at $t_c = 65$ °C 70 000 h, at $t_c = 70$ °C 50 000 h, at $t_c = 75$ °C

Quantity of drivers per miniature circuit breaker 16 A Type C

Based on $I_{cont}$	Based on inrush current $I_{peak}$	Typ. peak inrush current $I_{peak}$	1/2 value time, $\Delta t$	Calculated energy, $I_{peak}^2 \Delta t$
64 pcs	89 pcs	23 A	120 $\mu$ s	0.0458 A <sup>2</sup> s

CONVERSION TABLE FOR OTHER TYPES OF MINIATURE CIRCUIT BREAKER

MCB type	Relative quantity of LED drivers
B 10 A	37 %
B 16 A	60 %
B 20 A	75 %
C 10 A	62 %
C 16 A	100 % (see table above)
C 20 A	125 %

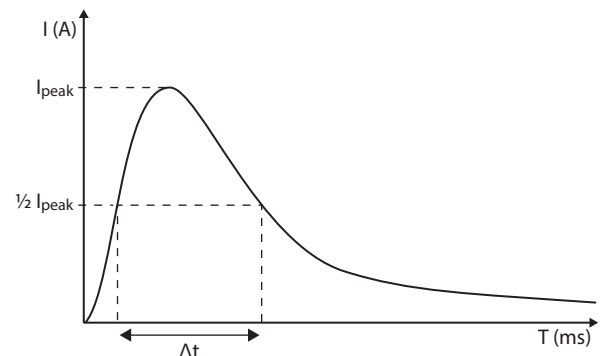

Type C MCB's are strongly recommended to use with LED lighting. Please see more details in "MCB information" document in each driver product page in "downloads & links" section.

Hybrid dimming technique per channel

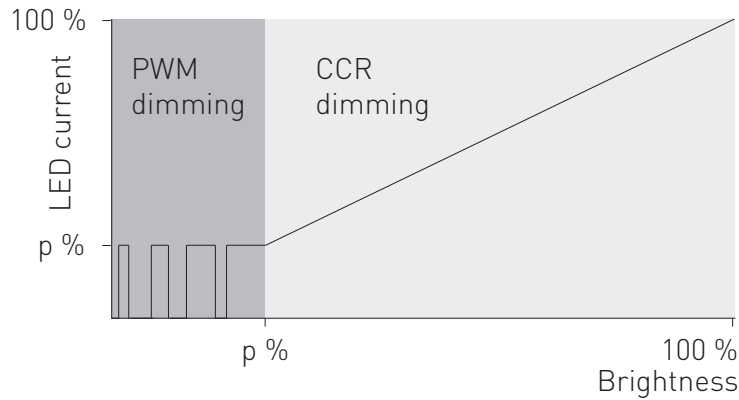

Dimming range/ch	Dimming technique
0.2 % – 20 %	Pulse Width Modulation (PWM)*
20 % – 100 %	Constant Current Reduction (CCR)

\* PWM dimming frequency 750 / 1500 Hz

Dynamic range in colour temperature control

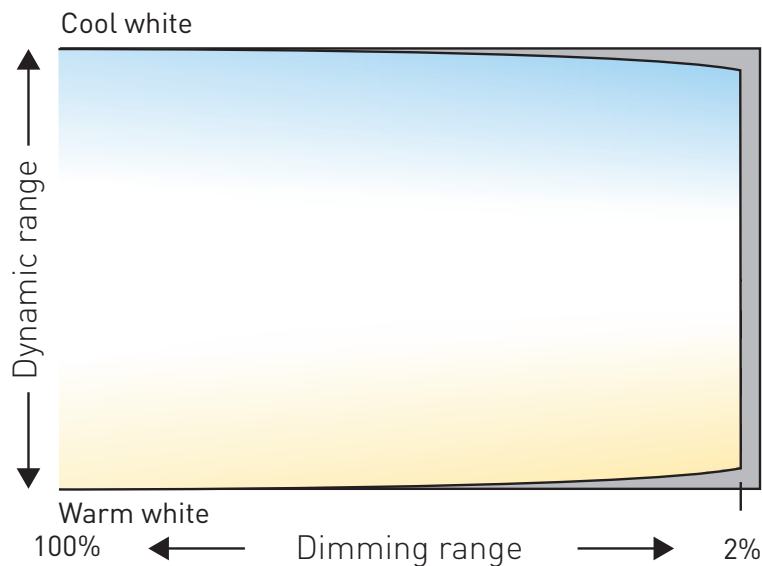

LC35/2-DA-iC LED driver is ready to be used out of the box.

Highest precision and color consistency in controlling combinations of different luminaire types is achieved by setting colour temperatures and lumen outputs before use with Helvar driver configurator. The configured colour temperatures of the channels should match the ones of the LED modules used. The factory default settings of cool and warm channels are 6500 K and 2700 K accordingly.

After setting up the colour temperatures, the lumen output values of full dimming level (100 %) should be configured for both channels. By default, output currents are set to be equal in both channels.

## Connections and Mechanical Data

Wire size	0.5 mm <sup>2</sup> – 1.5 mm <sup>2</sup>
Wire type	Solid core and fine-stranded
Wire insulation	According to EN 60598
Maximum driver to LED wire length	5 m
Weight	193 g
IP rating	IP20

## Connections

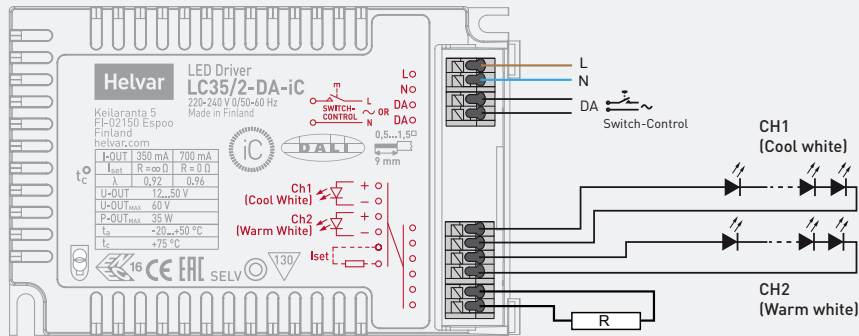

Note:

- Not suitable for load side switching operation.

## Dimensions (mm)

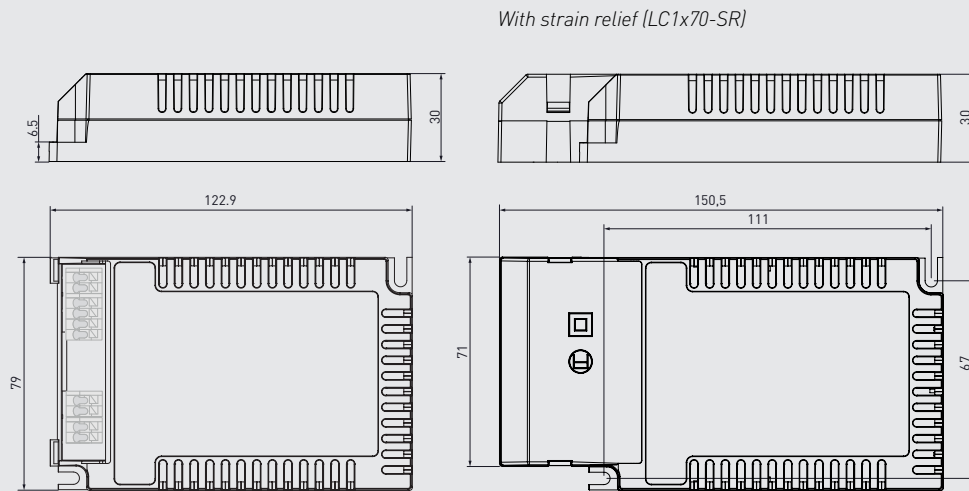

The LED-Iset resistor/current setting values are adjusted according to the LEDset specification. The resistor value for each required output current can thus be calculated from the formula  $R (\Omega) = (5 V) / I_{out} * 1000$ . Below are the available LED-Iset resistors from Helvar, pre-adjusted for the most common output currents.

### Helvar LED-Iset resistors and currents (Nominal $I_{out}$ (±5 % tol.))

LED-Iset resistor model	MAX	650 mA	600 mA	550 mA	500 mA	475 mA	450 mA	425 mA	400 mA	375 mA	No resistor
$I_{out}$ [mA]	700	650	600	550	500	475	450	425	400	375	350
Order code	T90000	T90650	T90600	T90550	T90500	T90475	T90450	T90425	T90400	T90375	N/A
Resistance values ( $\Omega$ )	0	7680	8250	9090	10.0k	10.5k	11.0k	11.8k	12.4k	13.3k	$\infty$

The current can be adjusted also with normal resistors by selecting suitable resistor value (formula  $R (\Omega) = (5 V) / I_{out} * 1000$ ).

LC35/2-DA-iC LED driver is suited for built-in usage in luminaires. With LC1x70-SR strain reliefs, independent use is possible too. In order to have safe and reliable LED driver operation, the LED luminaires will need to comply with the relevant standards and regulations (e.g. IEC/EN 60598-1). The LED luminaire shall be designed to adequately protect the LED driver from dust, moisture and pollution. The luminaire manufacturer is responsible for the correct choice and installation of the LED drivers according to the application and product datasheets. Operating conditions of the LED driver may never exceed the specifications as per the product datasheet.

## Installation & operation

### Maximum ambient and $t_c$ temperature:

- For built-in components inside luminaires, the  $t_a$  ambient temperature range is a guideline given for the optimum operating environment. However, integrator must always ensure proper thermal management (i.e. mounting base of the driver, air flow etc.) so that the  $t_c$  point temperature does not exceed the  $t_c$  maximum limit in any circumstance.
- Reliable operation and lifetime is only guaranteed if the maximum  $t_c$  point temperature is not exceeded under the conditions of use.

### Current setting resistor

LC35/2-DA-iC driver features a constant current output adjustable via current setting resistor or software.

- An external resistor can be inserted in to the current setting terminal, allowing the user to adjust the LED driver output current
- When no external resistor is connected, then the LED drivers will operate at their default lowest current level
- A standard through-hole resistor can be used for the current setting. To achieve the most accurate output current it is recommended to select a quality low tolerance resistor. Minimum diameter for resistor leg is 0.51mm.
- Always connect the current setting resistor only into the terminals marked with LED-Iset on the LED driver label.
- LED-Iset resistor/current values follow LEDset specification. For selection of the right current, refer to the tables on page 4.

### Miniature Circuit Breakers (MCB)

- Type-C MCB's with trip characteristics in according to EN 60898 are recommended.
- Please see more details in "MCB information" document in each driver product page in "downloads & links" section.

### Use of Switch-Control functionality

- Maximum numbers of LED drivers to be connected to one switch is 30.
- The maximum cabling length from the switch to the driver is 25 meters. If longer cabling is needed, please connect a capacitor across the Switch-Control input (1  $\mu$ F, min. 275 VAC rms and X2 rated).
- Ensure that all components connected to Switch-Control circuitry are mains rated.
- More information in Switch-Control User Guide at [www.helvar.com](http://www.helvar.com).

### Installation site

- The general preferred installation position of LED drivers for independent use is to have the top cover facing upwards.

## Helvar Driver Configurator support

LC35/2-DA-iC LED driver is supported by Helvar Driver configurator software. The driver supports output current setting with software, the output current of the driver can be programmed using Helvar Driver Configurator, as well as parameters for functions such as tunable white control behaviour and CLO. Also the operation of the multifunction Iset terminal usage can be changed from current setting resistor (default) to NTC overtemperature protection operation.

## Lamp failure functionality

**No load:** When open load is detected, driver remains checking if a valid load has been connected. Driver reports load failure condition to DALI.

**Short circuit:** When short circuit is detected, driver remains checking if a valid load has been connected. Driver reports load failure condition to DALI.

**Overload:** When high overload is detected (>53 V at least for 3 seconds), the driver will shut down the channel where overload is detected. When low overload is detected (< 53 V), output current will be reduced to have maximum rated output power.

**Underload:** When undervoltage is detected, driver follows the same functions described in short circuit condition.

**NTC trigger:** When NTC is enabled via Helvar Driver Configurator, driver follows NTC feature behaviour. Default NTC trigger point is 8,2 k $\Omega$ , after which the driver starts to decrease the output level.

## Conformity & standards

General and safety requirements	EN 61347-1:2015
Particular safety requirements for DC or AC supplied electronic control gear for LED modules	EN 61347-2-13: 2014 +A1:2016
Thermal protection class	EN 61347, C5e
Mains current harmonics	EN 61000-3-2: 2014
Limits for voltage fluctuations and flicker	EN 61000-3-3: 2013
Radio frequency interference	EN 55015: 2013
Immunity standard	EN 61547: 2009
Performance requirements	EN 62384: 2006+ A1:2009
<b>Digital addressing lighting interface:</b>	
General requirements for DALI system	EN 62386-101
Requirements for DALI control gear	EN 62386-102
Requirements for control gear of LED modules	EN 62386-207
Particular requirements for control gear - Colour control (DALI Device Type 8)*	EN 62386-209*
Independent usage acc. to relevant clauses of	EN 60598-1 : 2015
Compliant with relevant EU directives	
RoHS/REACH compliant	
CE marked	

\*The DALI colour control functionality of this product has not been verified.

## Label symbols



Safety isolating control gear with short circuit protection (SELV control gear).



Double insulated control gear suitable for built-in use.



Thermally controlled control gear, incorporating means of protection against overheating to prevent the case temperature under any conditions of use from exceeding 130 °C.