

DALI CW-WW LED Dimmer CC

Datasheet

Control Gear



DALI LED Dimmer (CC, DT8) for
the control of tunable white
luminaires (CW-WW)

common plus connector:

Art. Nr. 86458911-350 (350mA)

Art.Nr. 86458911-350DE (350mA)

Art. Nr. 86458911-500 (500mA)

Art. Nr. 86458911-500DE (500mA)

Art. Nr. 86458911-700 (700mA)

Art. Nr. 86458911-1000 (1000mA)

common minus connector:

Art.Nr. 86458911-350GMDE (350mA)

Art.Nr. 86458911-500GMDE (500mA)

Art. Nr. 86458911-700GM (700mA)

Art. Nr. 86458911-1000GM (1000mA)

DALI CW-WW LED-Dimmer CC Control Gear

Overview

- DALI LED-Dimmer for the control of tunable white luminaires
- suitable for constant current LED-modules
- **Operating Mode DT8:** one DALI-address for the independent control of light level and colour temperature (DALI DT8, Colour Type Tc)
- **Operating Mode Balance&Dim:** control by 2 DALI-addresses, one for adjusting the light level and one for adjusting the channel balance (e.g. colour temperature)
- **Operating Mode Dim2Warm:** one DALI-address for simultaneous adjustment of light level and colour temperature
- **SwitchDim2:** 2 switch-inputs offer control of level and colour without DALI
- dimming range 0.1%-100%
- adjustable PWM-frequency (122Hz/244Hz/488Hz/976Hz)
- types for constant currents of 350mA, 500mA, 700mA and 1000mA
- types with common plus and common minus connector available
- compact types for integration in luminaires or remote ceiling
- supply voltage from 12V to 48V DC
- output voltage up to 45VDC
- integrated short circuit protection
- low standby power consumption
- high efficiency
- configuration via PC-software DALI-Cockpit and DALI USB-interface
- user-friendly factory default settings

Specification, Characteristics

common plus connector:

type	DALI CW-WW 350/500mA	DALI CW-WW 350/500mA DE	DALI CW-WW 700mA	DALI CW-WW 1000mA
article number	86458911-350 / 86458911-500	86458911- 350DE/500DE	86458911-700	86458911-1000

electrical data:

supply voltage V_{in}	12VDC-48VDC			
max. input current I_{inmax}	350mA / 500mA	350mA / 500mA	700mA	1000mA
max. output current I_{led}	350mA / 500mA	350mA / 500mA	700mA	1000mA
output voltage range V_{led}	3V-45V (at 48V supply)			
control input	DALI	DALI SwitchDim2		
current consumption DALI	2mA			
number of DALI-addresses	operating mode DT8, Dim2Warm: 1 operating mode Balance&Dim: 2			
standby power consumption (12V)	~ 180 mW			

type	DALI CW-WW 350/500mA	DALI CW-WW 350/500mA DE	DALI CW-WW 700mA	DALI CW-WW 1000mA
------	-------------------------	----------------------------	---------------------	----------------------

technical data:

power on behaviour	configurable via DALI: 0%-100% or last value			
ambient temperature	-15°C to +50°C	-20°C to +60°C		
expected lifetime	>100000h at Tc<65°C	>100000h at Tc<75°C		
protection class	IP20			
max. connecting wire cross section	up to 1.5 mm ²	up to 1.5 mm ² , supply (V+, V-): up to 2.5 mm ²		
dimensions (LxWxH)	59mm x 33mm x 15mm	120mm x 30mm x 22mm	120mmx41mmx22mm	
housing/mounting	back box	remote ceiling		

on request: output currents from 100mA to 1000mA available

for constant currents up to 500mA:

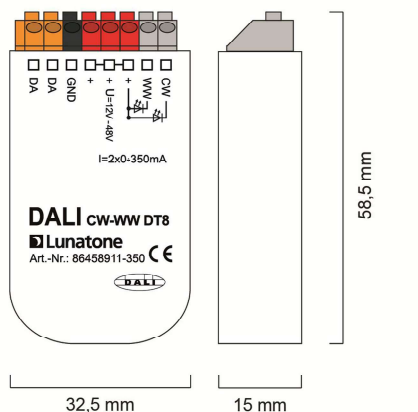

dimensions (common plus, back box)

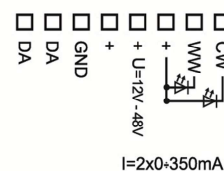

connection plan (common plus, back box)

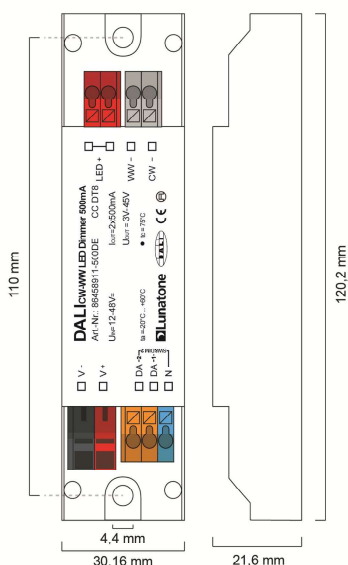

dimensions (common plus, remote ceiling)



connection plan (common plus, remote ceiling)

for constant currents >500mA

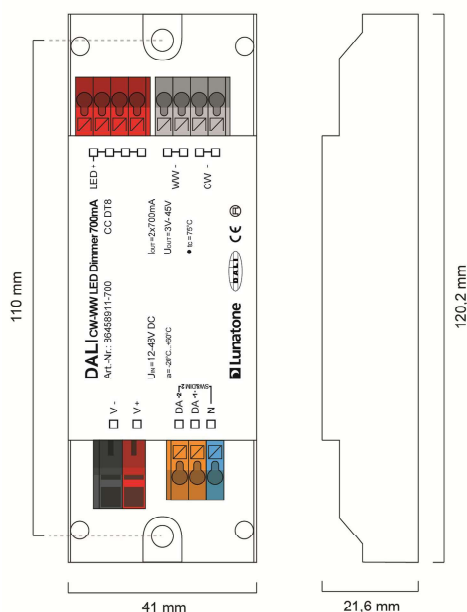

dimensions (common plus, remote ceiling)



connection plan (common plus, remote ceiling)

common minus connector:

type	DALI CW-WW 350/500mA GMDE	DALI CW-WW 700mA GM	DALI CW-WW 1000mA GM
article number	86458911- 350GMDE/500GMDE	86458911-700GM	86458911-1000GM

electrical data:

supply voltage V_{in}	12VDC-48VDC		
max. input current I_{inmax}	350/500mA	700mA	1000mA
max. output current I_{led}	350/500mA	700mA	1000mA
output voltage range V_{led}	3V-45V (at 48V supply)		
control input	DALI SwitchDim2		
current consumption DALI	2mA		
number of DALI-addresses	operating mode DT8, Dim2Warm: 1 operating mode Balance&Dim: 2		
standby power consumption (12V)	180 mW		

technical data:

power on behaviour	configurable via DALI: 0%-100% or last value		
ambient temperature	-20°C bis +60°C		
expected lifetime	>100000h (at $T_c < 75^\circ\text{C}$)		
protection class	IP20		
max. connecting wire cross section	up to 1.5 mm ² , supply (V+, V-): up to 2.5 mm ²		
dimensions (LxWxH)	120mmx30mmx22mm	120mmx41mmx22mm	
housing/mounting	remote ceiling		

on request: output currents from 100mA to 1400mA available

for constant currents up to 500mA (on request up to 700mA):

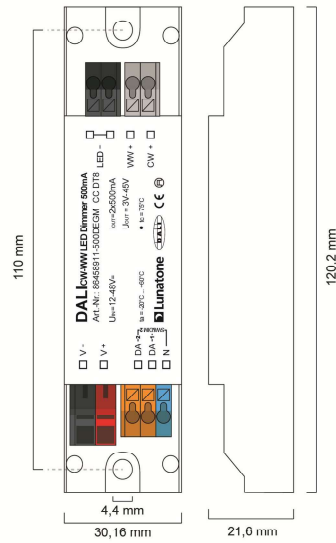

dimensions (common minus, remote ceiling)

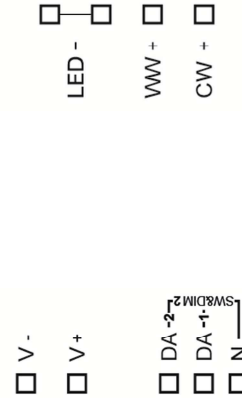

connection plan

for constant currents > 500mA:

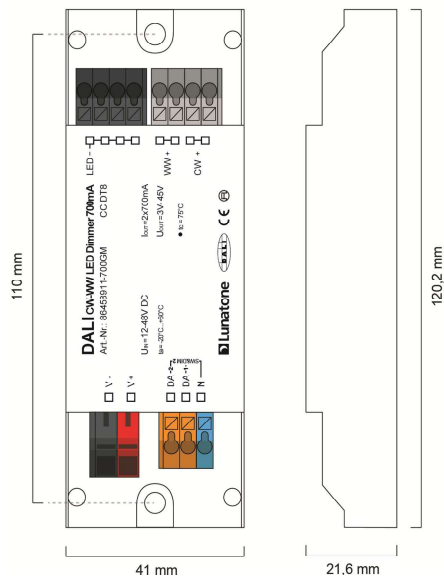

dimensions (common minus, remote ceiling)

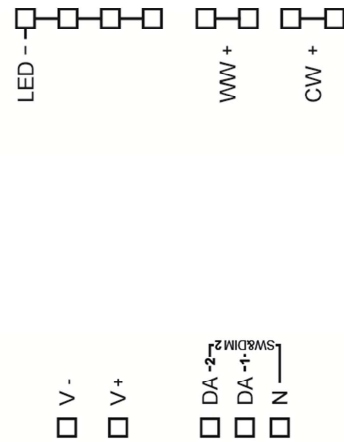

connection plan



Hint:
For highest efficiency the input voltage should range between 3V and 10V above the LED-voltage:

- 4-6 LEDs: 24V
- 6-9 LEDs: 36V
- 10-12 LEDs: 48V

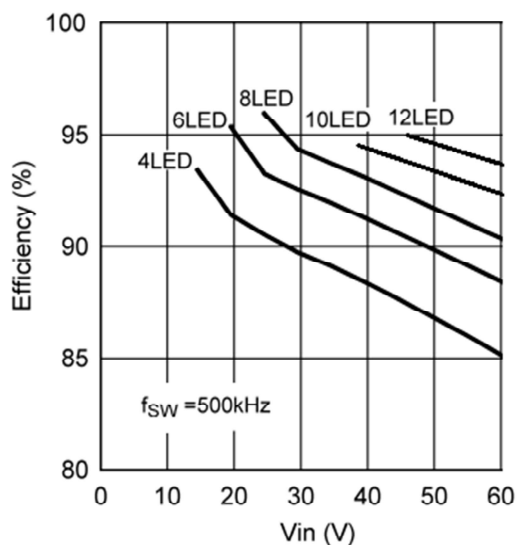

DALI (common plus connector type):

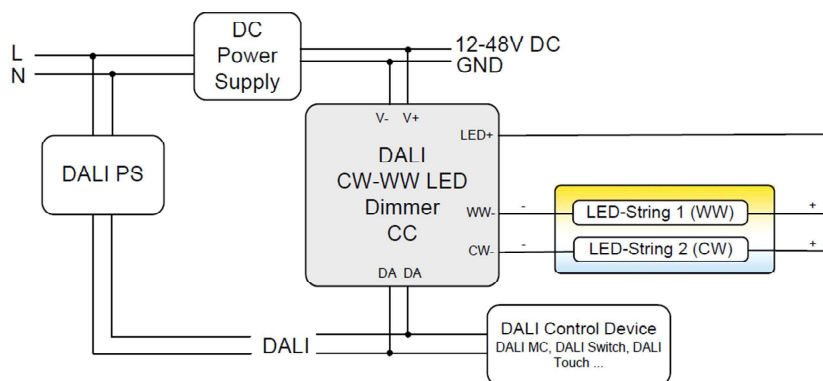

SwitchDim2 (common plus connector type):

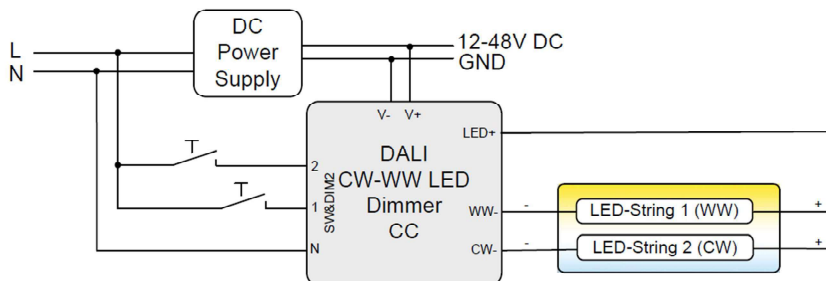

Operating Modes

The device offers several operating modes:

DT8 (factory default)

Default when connected to DALI in this operating mode one DALI-address for the independent control of light level and colour temperature is used (Device Type 8 Mode Tc).

Alternatively the device can be controlled using 2 switch-inputs for mains voltage (SwitchDim2):

SwD1: light level

short press: On/Off

long press: dimming

SwD2: colour temperature

long press: change colour temperature

Balance&Dim

This operating mode is also suitable for operating tunable white luminaires using two DALI-addresses. The first controls the light level and the second is used for changing the distribution on the output channels (e.g. for tunable white applications or balancing direct/indirect lighting).

The Balance&Dim mode allows colour temperature adjustments without affecting the light level and vice versa. For each channel only DALI-standard commands like dim up/down but also DAP are used. Thus the device can be used with all common controls and gateways (e.g. KNX). The Balance&Dim mode provides an alternative to the DT8-Tc mode.

Can be operated via DALI or SwitchDim2:

DALI-address 1, SwD1: light level

DALI-address 2, SwD2: balance

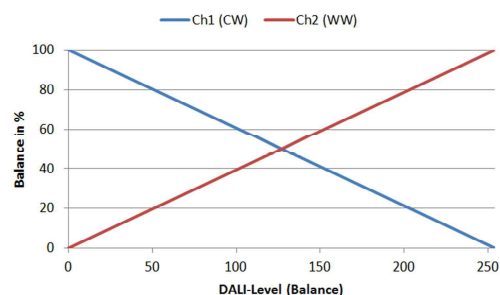

Dim2Warm

Both output channels are controlled by one DALI-address or SwD-input. The balance is coupled directly to the DALI dim level – the smaller the dim level the warmer the light.

DALI-address 1, SwD1: Dim2Warm (Master)

short press: On/Off

long press: dimming

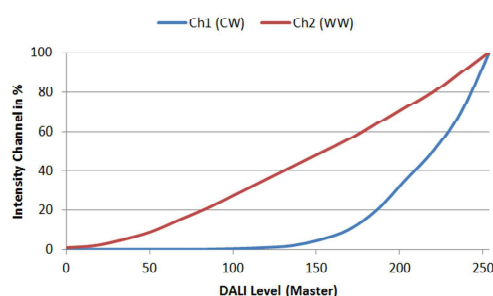

SwD2: scene selector

Selection of operating mode

With the help of the PC-software tool DALI-Cockpit the operating mode can be easily set on the general settings page.

Operating mode DT8-Tc:

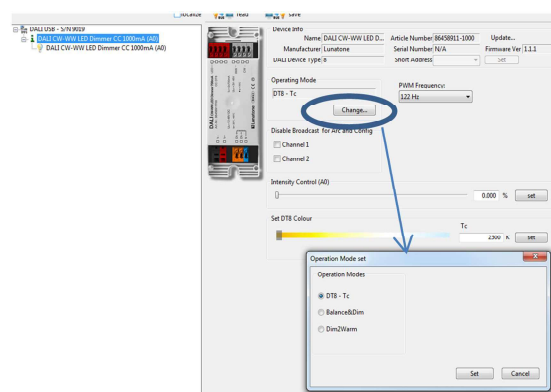

In addition, on the same page the PWM-frequency can be selected and basic control elements for testing each operating modes are available (DT8: slider for level and colour temperature, Balance&Dim: slider for level and balance, Dim2Warm: slider for input value adaption and Edit-Function for the Dim2Warm-table). Furthermore the broadcast control can be deactivated for each channel individually.

Operating Mode Balance&Dim:

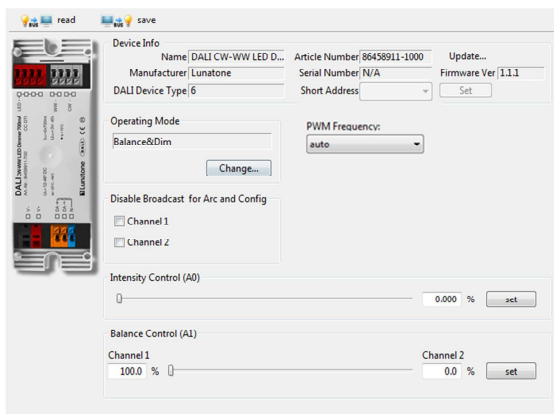

Operating Mode Dim2Warm:

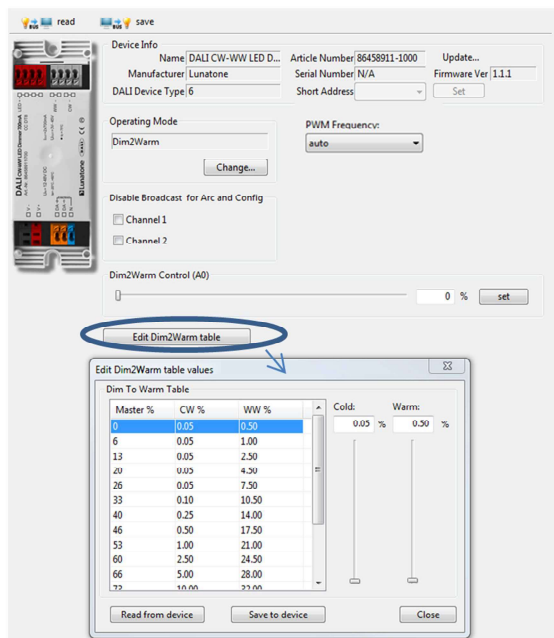

Switching between operating modes can also be done with the help of the DALI-command SET OPERATING MODE (IEC 62386-102 Ed.2). When changing the operating mode the number of used DALI-addresses can change as

well and this requires a new addressing procedure. In the DALI-Cockpit this address assignment is performed automatically.

Operating Mode:

Number	Operating Mode
0x0	DT8 (factory default)
0x92	DT8
0x94	Balance&Dim
0x95	Dim2Warm

Additional Settings

Besides the settings on the general page each channel can be selected separately in the component tree for individual configuration.

Component Tree:

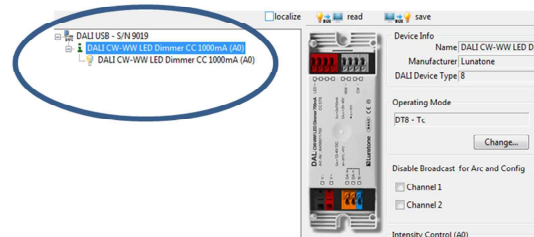

Settings in the operating mode DT8-Tc (displayed parameters are the factory default values):

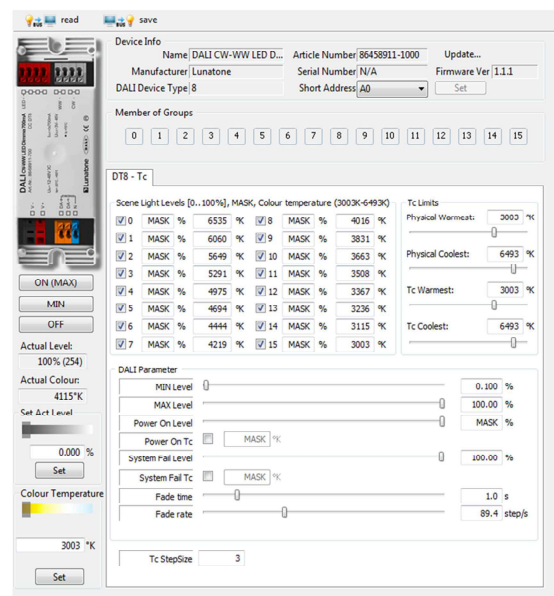

Beside the DT8 Tc standard settings, the Tc stepsize can be increased, this is a simple way to speed up colour temperature changes when using the commands TC STEP COOLER/WARMER.

In all other operating modes (Balance&Dim /Dim2Warm) the following settings are provided.

Operating mode Balance&Dim; Dim2Warm:

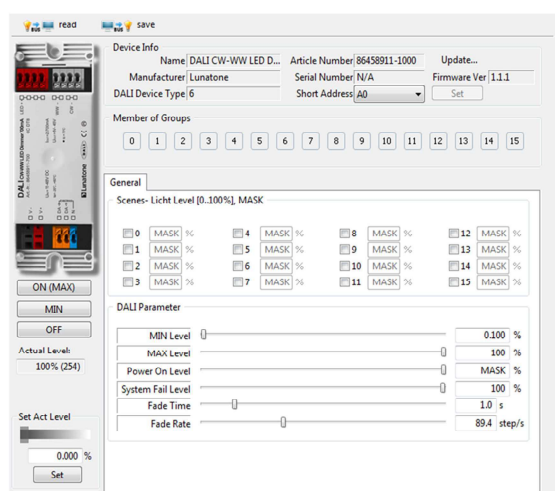

For each address the group membership can be set as well as scene values and DALI-parameters. In Balance&Dim operating mode all values assigned to channel 2 are representing the balance.

Factory Default Settings

Before the initial addressing is performed, the device can already be controlled by a group address. This predefined grouping will be deleted during the first addressing procedure. Afterwards groups can be assigned as usual (e.g. with the help of the DALI Cockpit).

Summary of the factory default settings (delivery state):

operating mode	DT8
SwitchDim2	SwD1: level SwD2: colour temperature

Min Level	0.1%																																																																																																
PowerOn Level	MASK (last value)																																																																																																
Fade Time	2 (1s)																																																																																																
Fade Rate	5 (89.4 steps/s)																																																																																																
Tc-Stepsize	3 increments																																																																																																
PWM-frequency	auto																																																																																																
Groups before initial addressing:	G0 (or G0 and G1 in operating mode Balance&Dim)																																																																																																
Predefined Scene Values:	<table border="1"> <tr><td><input checked="" type="checkbox"/></td><td>0</td><td>MASK</td><td>%</td><td>6535</td><td>°K</td><td><input checked="" type="checkbox"/></td><td>8</td><td>MASK</td><td>%</td><td>4016</td><td>°K</td></tr> <tr><td><input checked="" type="checkbox"/></td><td>1</td><td>MASK</td><td>%</td><td>6060</td><td>°K</td><td><input checked="" type="checkbox"/></td><td>9</td><td>MASK</td><td>%</td><td>3831</td><td>°K</td></tr> <tr><td><input checked="" type="checkbox"/></td><td>2</td><td>MASK</td><td>%</td><td>5649</td><td>°K</td><td><input checked="" type="checkbox"/></td><td>10</td><td>MASK</td><td>%</td><td>3663</td><td>°K</td></tr> <tr><td><input checked="" type="checkbox"/></td><td>3</td><td>MASK</td><td>%</td><td>5291</td><td>°K</td><td><input checked="" type="checkbox"/></td><td>11</td><td>MASK</td><td>%</td><td>3508</td><td>°K</td></tr> <tr><td><input checked="" type="checkbox"/></td><td>4</td><td>MASK</td><td>%</td><td>4975</td><td>°K</td><td><input checked="" type="checkbox"/></td><td>12</td><td>MASK</td><td>%</td><td>3367</td><td>°K</td></tr> <tr><td><input checked="" type="checkbox"/></td><td>5</td><td>MASK</td><td>%</td><td>4694</td><td>°K</td><td><input checked="" type="checkbox"/></td><td>13</td><td>MASK</td><td>%</td><td>3236</td><td>°K</td></tr> <tr><td><input checked="" type="checkbox"/></td><td>6</td><td>MASK</td><td>%</td><td>4444</td><td>°K</td><td><input checked="" type="checkbox"/></td><td>14</td><td>MASK</td><td>%</td><td>3115</td><td>°K</td></tr> <tr><td><input checked="" type="checkbox"/></td><td>7</td><td>MASK</td><td>%</td><td>4219</td><td>°K</td><td><input checked="" type="checkbox"/></td><td>15</td><td>MASK</td><td>%</td><td>3003</td><td>°K</td></tr> </table>	<input checked="" type="checkbox"/>	0	MASK	%	6535	°K	<input checked="" type="checkbox"/>	8	MASK	%	4016	°K	<input checked="" type="checkbox"/>	1	MASK	%	6060	°K	<input checked="" type="checkbox"/>	9	MASK	%	3831	°K	<input checked="" type="checkbox"/>	2	MASK	%	5649	°K	<input checked="" type="checkbox"/>	10	MASK	%	3663	°K	<input checked="" type="checkbox"/>	3	MASK	%	5291	°K	<input checked="" type="checkbox"/>	11	MASK	%	3508	°K	<input checked="" type="checkbox"/>	4	MASK	%	4975	°K	<input checked="" type="checkbox"/>	12	MASK	%	3367	°K	<input checked="" type="checkbox"/>	5	MASK	%	4694	°K	<input checked="" type="checkbox"/>	13	MASK	%	3236	°K	<input checked="" type="checkbox"/>	6	MASK	%	4444	°K	<input checked="" type="checkbox"/>	14	MASK	%	3115	°K	<input checked="" type="checkbox"/>	7	MASK	%	4219	°K	<input checked="" type="checkbox"/>	15	MASK	%	3003	°K
<input checked="" type="checkbox"/>	0	MASK	%	6535	°K	<input checked="" type="checkbox"/>	8	MASK	%	4016	°K																																																																																						
<input checked="" type="checkbox"/>	1	MASK	%	6060	°K	<input checked="" type="checkbox"/>	9	MASK	%	3831	°K																																																																																						
<input checked="" type="checkbox"/>	2	MASK	%	5649	°K	<input checked="" type="checkbox"/>	10	MASK	%	3663	°K																																																																																						
<input checked="" type="checkbox"/>	3	MASK	%	5291	°K	<input checked="" type="checkbox"/>	11	MASK	%	3508	°K																																																																																						
<input checked="" type="checkbox"/>	4	MASK	%	4975	°K	<input checked="" type="checkbox"/>	12	MASK	%	3367	°K																																																																																						
<input checked="" type="checkbox"/>	5	MASK	%	4694	°K	<input checked="" type="checkbox"/>	13	MASK	%	3236	°K																																																																																						
<input checked="" type="checkbox"/>	6	MASK	%	4444	°K	<input checked="" type="checkbox"/>	14	MASK	%	3115	°K																																																																																						
<input checked="" type="checkbox"/>	7	MASK	%	4219	°K	<input checked="" type="checkbox"/>	15	MASK	%	3003	°K																																																																																						

Purchase Order Information

Art.Nr. 86458911-xxx: DALI CW-WW LED Dimmer, CC – constant current xxxmA, **common plus connector**, supply 12V-48V DC, output voltage range: 3V-45V , 100mA - 500mA, back box

Art.Nr. 86458911-xxxDE: DALI CW-WW LED Dimmer, CC – constant current xxxmA, **common plus connector**, supply 12V-48V DC, output voltage range: 3V-45V, **SwitchDim2**, 100mA-500mA, remote ceiling & integration in luminaires

Art.Nr. 86458911-xxx: DALI CW-WW LED Dimmer, CC – constant current xxxmA, **common plus connector**, supply 12V-48V DC, output voltage range: 3V-45V, **SwitchDim2**, 500mA -1000mA, remote ceiling & integration in luminaires

Art.Nr. 86458911-xxxGMDE: DALI CW-WW LED Dimmer, CC – constant current xxxmA, **common minus connector**, supply 12V-48V DC, output voltage range: 3V-45V, **SwitchDim2**, 100mA-500mA, remote ceiling & integration in luminaires

Art.Nr. 86458911-xxxGM: DALI CW-WW LED Dimmer, CC – constant current xxxmA, **common minus connector**, supply 12V-48V DC, output voltage range: 3V-45V, **SwitchDim2**, 500mA -1400mA, remote ceiling & integration in luminaires

Additional Information and Equipment

DALI-Cockpit – free configuration tool from Lunatone for DALI systems
<http://lunatone.at/en/downloads/Lunatone-DALI-Cockpit.zip>

Lunatone DALI products
<http://www.lunatone.at/en/>

Lunatone datasheets and manuals
<http://lunatone.at/en/downloads/>

Contact

Technical Support: support@lunatone.com

Requests: sales@lunatone.com

www.lunatone.com



Disclaimer

Subject to change. Information provided without guarantee.
The datasheet refers to the current delivery.

The compatibility with other devices must be tested in advance to the installation.