

DALI RGB LED Dimmer CV

Datasheet Control Gear

RGB LED Dimmer (CV, DT8)



Art. Nr. 89453837 (4A)

Art. Nr. 86458514 (8A)

Art. Nr. 89453839 (10A)

Art. Nr. 89453842 (16A)

DALI RGB LED Dimmer CV Control Gear

Overview

- DALI LED-Dimmer for RGB colour control
- suitable for constant voltage LED-modules
- **Operating Mode DT8:** one DALI-address for the independent control of light level and colour (DALI DT8, Type RGBWAF)
- **Operating Mode Colour&Dim:** control by 2 DALI-addresses, one for adjusting the light level and one for adjusting the colour
- **SwitchDim2:** 2 switch-inputs offer control of light level and colour without DALI
- dimming range 0.1%-100%
- adjustable PWM-frequency (122Hz/244Hz/488Hz/976Hz)
- compact types for integration in luminaires or remote ceiling
- supply voltage 12V to 48V DC
- type dependent max. input currents of 4A, 8A, 10A or 16A
- the maximum input current can be distributed on the channels at will
- low standby power consumption
- high efficiency
- configuration via PC-software DALI-Cockpit and DALI USB-interface
- user-friendly factory default settings

Specification, Characteristics

type	DALI RGB LED Dimmer CV			
article number	89453837	86458514	89453839	89453842
electrical data:				
supply voltage	12VDC-48VDC			
maximum input current linmax	4A	8A	10A	16A
control input	DALI SwitchDim2 (mains voltage)			
current consumption DALI	2mA			
number of DALI-addresses	operating mode DT8: 1 operating mode Colour&Dim: 2			
standby power consumption (12V)	~ 120mW			
technical data:				
power on behaviour	configurable: 0%-100% or last value			
ambient temperature	-20°C to +60°C			
expected lifetime (at Tc<=75°C)	>100000h			
protection class	IP20			
max. connecting wire cross section	1.5 mm ²	2.5 mm ² / DALI &SwDim: 1.5 mm ²		
dimensions (LxWxH)	59x33x15 mm	120x30x22 mm		
housing/mounting	back box	remote ceiling		

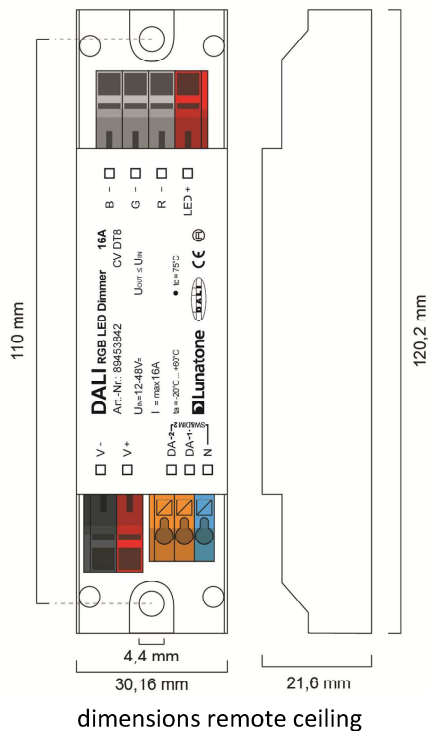

dimensions remote ceiling

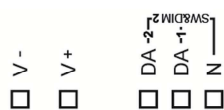
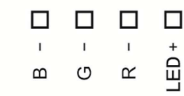

connection plan remote ceiling

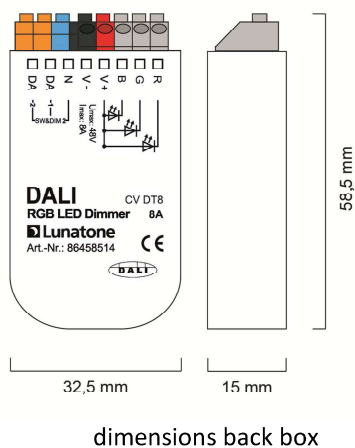

dimensions back box

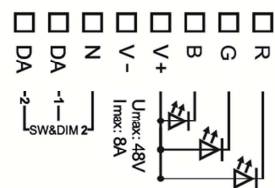

connection plan back box

RECOMMENDATION: Care should be taken on keeping cable lengths between DC power supply and dimmer as well as between dimmer and luminaires (Led-Strings) as short as possible. This kind of installation will minimize the influence of voltage drops.

DALI:

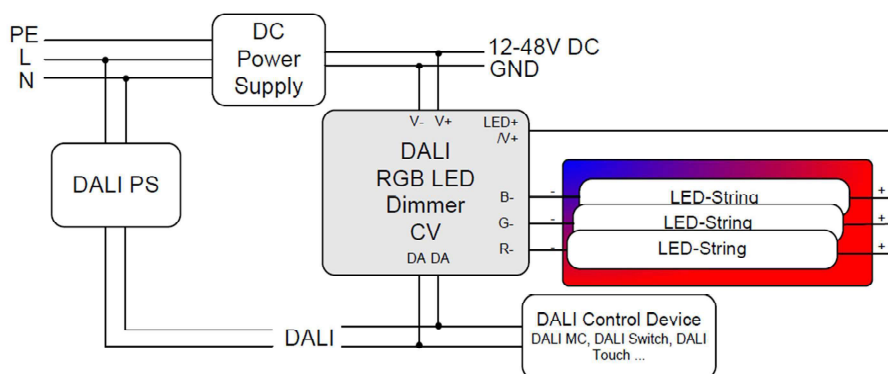

SwitchDim2:

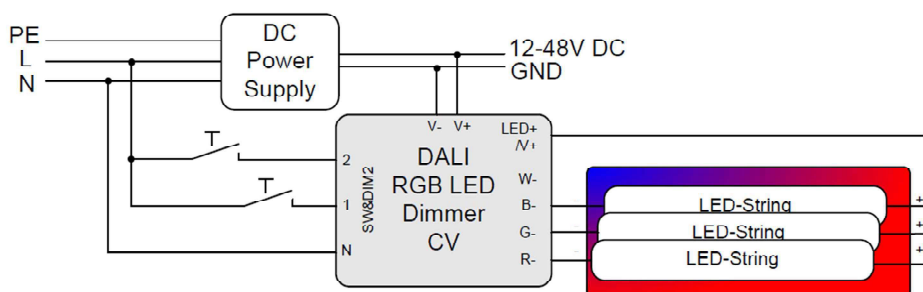

Operating Modes

The device offers several operating modes:

DT8 (factory default)

In this operating mode one DALI-address for the independent control of light level and colour is used (Device Type 8 RGBWAF).

Alternatively the device can be controlled using 2 switch-inputs for mains voltage (SwitchDim2):

SwD1: light level

- short press: On/Off
- long press: dimming

SwD2: colour

- long press: change colour

Colour&Dim

This operating mode is suitable for operating RGB—luminaires. Two DALI-addresses are

used, the first to control the light level and the second for changing the distribution on the output channels (e.g. for colour adjustments).

The Colour&Dim mode allows colour adjustments without affecting the level and vice versa. For each channel only DALI-standard commands like dim up/down but also DAP are used. Thus the device can be used with all common controls and gateways (e.g. KNX). The Colour&Dim mode provides an alternative to the DT8-RGBWAF mode.

Can be operated via DALI or SwitchDim2:

DALI-address 1, SwD1: light level

DALI-address 2, SwD2: colour

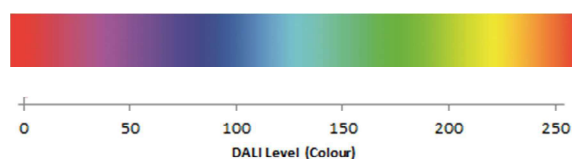

Selection of operating mode

With the help of the PC-software tool DALI-Cockpit the operating mode can be easily set on the general settings page.

Operating mode DT8-RGBWAF:

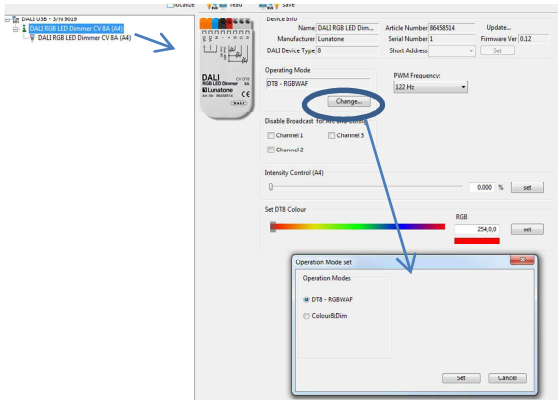

In addition, on the same page the PWM-frequency can be selected and basic control elements for testing each operating modes are available (slider for level and colour in the operating modes DT8 and Colour&Dim). Furthermore the broadcast control can be deactivated for each channel individually.

Operating mode Colour&Dim:

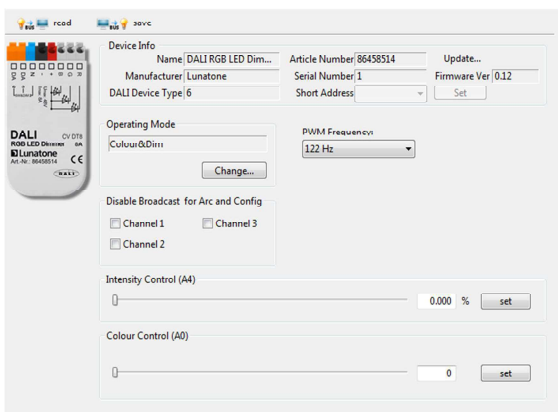

Switching between operating modes can also be done with the help of the DALI-command SET OPERATING MODE (IEC 62386-102 Ed.2). When changing the operating mode the number of used DALI-addresses can change as well and this requires a new addressing procedure. In the DALI-Cockpit this address assignment is performed automatically.

Operating Mode:

number	operating mode
0x0	DT8 (factory default)
0x92	DT8
0x93	Colour&Dim

Additional Settings

Besides the settings on the general page each channel can be selected separately in the component tree for individual configuration.

Component Tree:

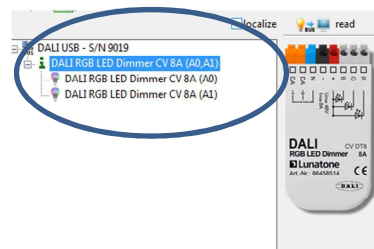

Settings in the operating mode DT8-RGBWAF (displayed parameters are the factory default values)

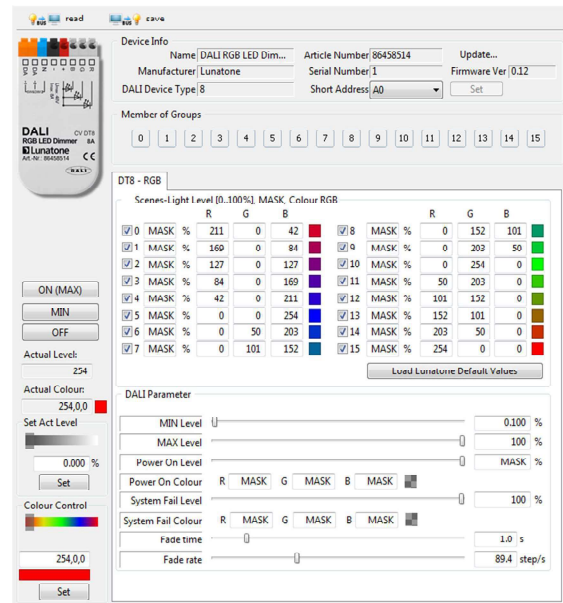

Settings for each channel in the operating mode Colour&Dim:

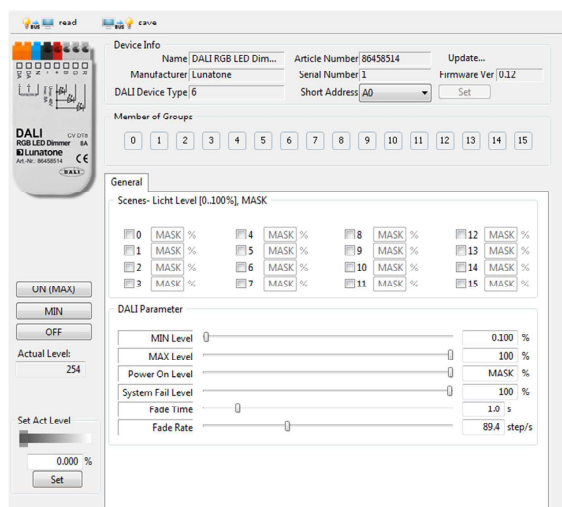

For each address the group membership can be set as well as scene values and DALI-parameters. In Colour&Dim operating mode, all values assigned to channel 2 are representing colours.

Factory Default Settings

Before the initial addressing is performed, the device can already be controlled by a group address.

Summary of the factory default settings (delivery state):

Operating mode	DT8
SwitchDim2	SwD1: level SwD2: colour
Min Level	0.1%
PowerOn Level	MASK (last value)
Fade Time	2 (1s)
Fade Rate	5 (89.4 steps/s)
PWM-frequency	Auto
Groups before initial addressing:	G0 (or G0 and G1 in operating mode Colour&Dim)

Predefined Scene Values:

		R	G	B
<input checked="" type="checkbox"/> 0	MASK %	211	0	42
<input checked="" type="checkbox"/> 1	MASK %	169	0	84
<input checked="" type="checkbox"/> 2	MASK %	127	0	127
<input checked="" type="checkbox"/> 3	MASK %	84	0	169
<input checked="" type="checkbox"/> 4	MASK %	42	0	211
<input checked="" type="checkbox"/> 5	MASK %	0	0	254
<input checked="" type="checkbox"/> 6	MASK %	0	50	203
<input checked="" type="checkbox"/> 7	MASK %	0	101	152
<input checked="" type="checkbox"/> 8	MASK %	0	152	101
<input checked="" type="checkbox"/> 9	MASK %	0	203	50
<input checked="" type="checkbox"/> 10	MASK %	0	254	0
<input checked="" type="checkbox"/> 11	MASK %	50	203	0
<input checked="" type="checkbox"/> 12	MASK %	101	152	0
<input checked="" type="checkbox"/> 13	MASK %	152	101	0
<input checked="" type="checkbox"/> 14	MASK %	203	50	0
<input checked="" type="checkbox"/> 15	MASK %	254	0	0

Purchase Order Information

Art.Nr. 89453837: RGB LED Dimmer, CV, input current 4A, 12V-48V DC, SwitchDim2, back box

Art.Nr. 86458514: RGB LED Dimmer, CV, input current 8A, 12V-48V DC, SwitchDim2, back box

Art.Nr. 89453839: RGB LED Dimmer, CV, input current 10A, 12V-48V DC, SwitchDim2, remote ceiling & integration in luminaires

Art.Nr. 89453842: RGB LED Dimmer, CV, input current 16A, 12V-48V DC, SwitchDim2, remote ceiling & integration in luminaires

Additional Information and Equipment

DALI-Cockpit – free configuration tool from Lunatone for DALI systems

<http://lunatone.at/en/downloads/Lunatone-DALI-Cockpit.zip>

Lunatone DALI products

<http://www.lunatone.at/en/>

Lunatone datasheets and manuals

<http://lunatone.at/en/downloads/>

Contact

Technical Support: support@lunatone.com

Requests: sales@lunatone.com

www.lunatone.com

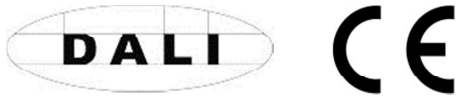

Disclaimer

Subject to change. Information provided without guarantee.
The datasheet refers to the current delivery.

The compatibility with other devices must be tested in advance
to the installation.