

DALI 3Ch LED Dimmer CC



Datasheet Control Gear

3-channel LED Dimmer (CC, DT6)

common plus connector:

Art. Nr. 89453846-350 (350mA)

Art. Nr. 89453846-500 (500mA)

common minus connector:

Art. Nr. 89453846-350GM (350mA)

Art. Nr. 89453846-500GM (500mA)

Art. Nr. 89453846-700GM (700mA)

DALI 3Ch LED Dimmer CC Control Gear

Overview

- 3 channel DALI LED-Dimmer
- suitable for constant current LED-modules
- **Operating Mode DT6:** individual channel control via 3 DALI addresses
- **Operating Mode Colour&Dim:** control by 2 DALI-addresses, one for adjusting the light level and one for adjusting the colour
- **SwitchDim2:** 2 switch-inputs offer control of light level and colour without DALI
- dimming range 0.1%-100%
- adjustable PWM-frequency (122Hz/244Hz/488Hz/976Hz)
- types with common plus connector with constant currents up to 500mA
- types with common minus connector with constant currents up to 700mA
- suitable for integration in luminaires and remote ceiling
- supply voltage 12V to 48V DC
- output voltage up to 45VDC
- short circuit protection
- low standby power consumption
- high efficiency
- configuration via PC-software DALI-Cockpit and DALI USB-interface
- user-friendly factory default settings

Specification, Characteristics

common plus connector:

type	DALI 3Ch 350mA GP	DALI 3Ch 500mA GP
article number	89453846-350	89453846-500
electrical data:		
supply voltage V_{in}	12VDC-48VDC	
max. input current I_{inmax}	1050mA	1500mA
max. output current per channel I_{led}	350mA	500mA
output voltage range V_{led}	3V-45V (at 48V supply)	
control input	DALI / SwitchDim2 (mains voltage)	
current consumption DALI	2mA	
number of DALI-addresses	operating mode DT6: 3 operating mode Colour&Dim: 2	
standby power consumption (12V)	~ 180mW	
technical data:		
power on behaviour	configurable via DALI: 0%-100% or last value	
ambient temperature	-20°C to +60°C	
expected lifetime	>100000h (at $T_c \leq 75^\circ C$)	
protection class	IP20	
max. connecting wire cross section	up to 1.5 mm ² , supply (V+, V-): up to 2.5 mm ²	
dimensions (LxWxH)	120mmx30mmx22 mm	
housing/mounting	remote ceiling	

on request: output currents from 100mA to 500mA available

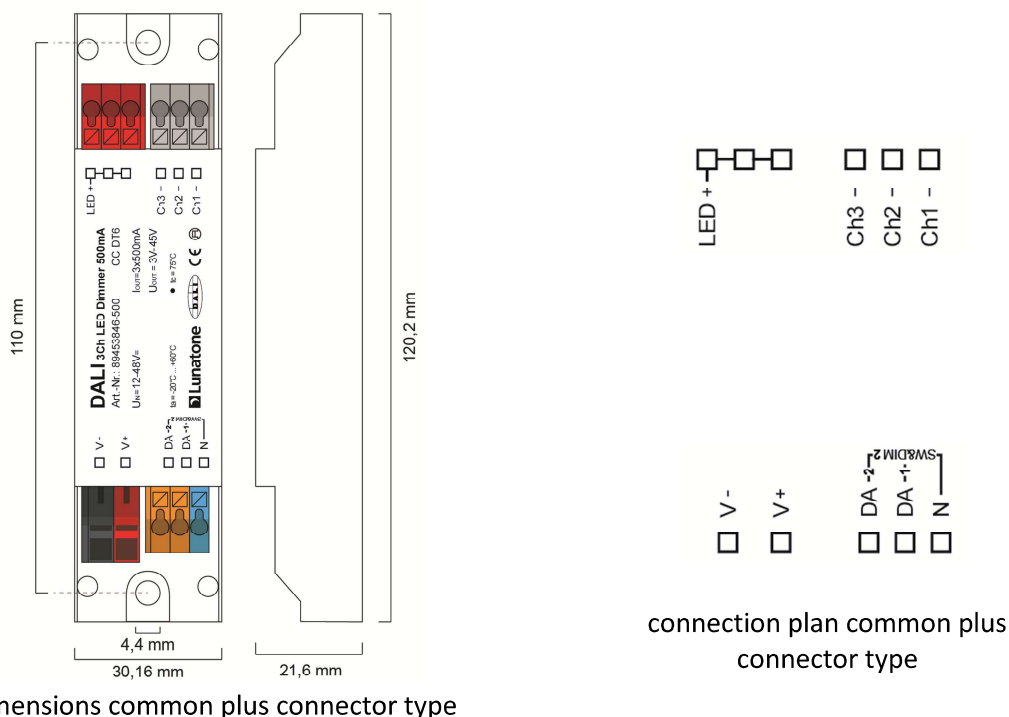

common minus connector:

type	DALI 3Ch 350mA GM	DALI 3Ch 500mA GM	DALI 3Ch 700mA GM
article number	89453846-350GM	89453846-500GM	89453846-700GM

electrical data:			
supply voltage V_{in}	12VDC-48VDC		
max. input current I_{inmax}	1050mA	1500mA	2100mA
max. output current per channel I_{led}	350mA	500mA	700mA
output voltage range V_{led}	3V-45V (at 48V supply)		
control input	DALI SwitchDim2 (mains voltage)		
current consumption DALI	2mA		
number of DALI-addresses	operating mode DT6: 3 operating mode Colour&Dim: 2		
standby power consumption (12V)	~ 180mW		

technical data:	
power on behaviour	Configurable via DALI: 0%-100% or last value
ambient temperature	-20°C to +60°C
expected lifetime	>100000h (at $T_c \leq 75^\circ\text{C}$)
protection class	IP20
max. connecting wire cross section	up to 1.5 mm ² , supply (V+, V-): up to 2.5 mm ²
dimensions (LxWxH)	120mmx30mmx22 mm
housing/mounting	remote ceiling

on request: output currents from 100mA to 700mA available

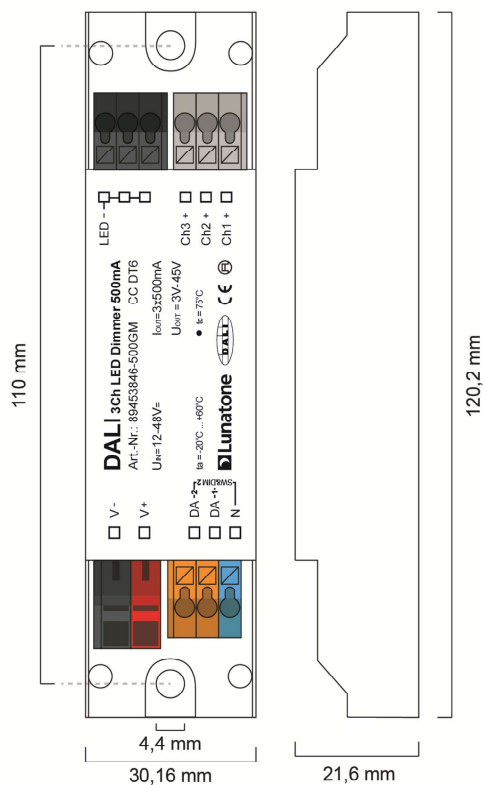

dimensions GM



connection plan GM



Hint:

For highest efficiency the input voltage should range between 3V and 10V above the LED-voltage:

- 4-6 LEDs: 24V
- 6-9 LEDs: 36V
- 10-12 LEDs: 48V

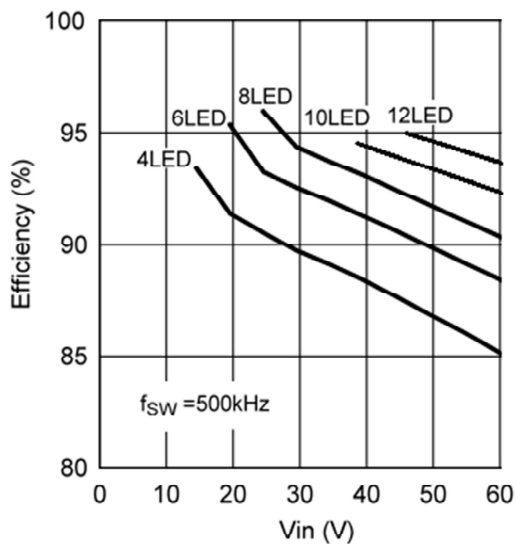

DALI (common plus connector type):

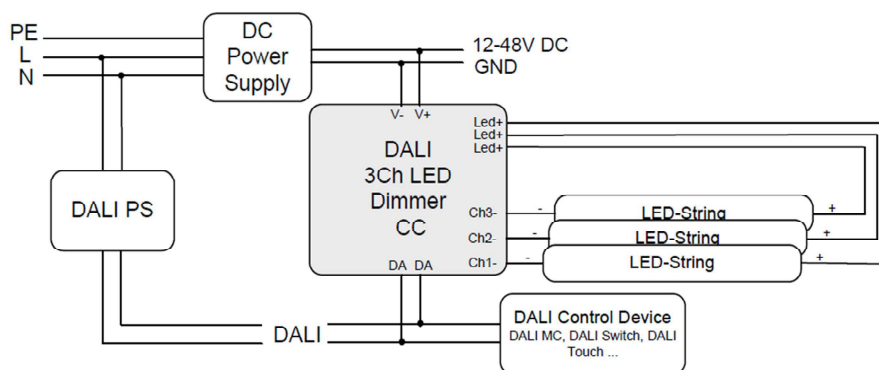

SwitchDim2 (common plus connector type):

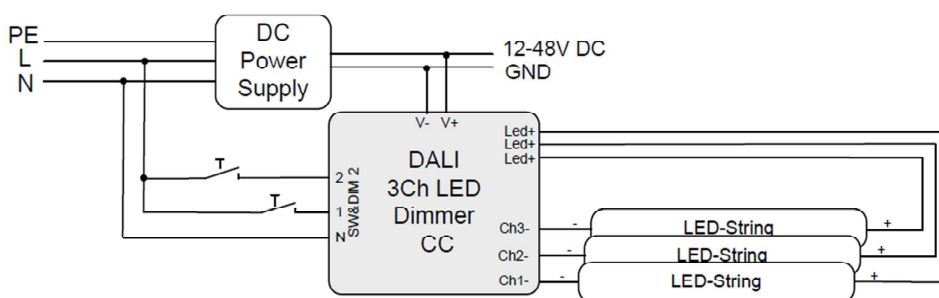

Operating Modes

The device offers several operating modes:

DT6 (factory default)

In this operating mode each channel can be controlled by its own DALI address (Device Type 6).

Alternatively the device can be controlled using 2 switch-inputs for mains voltage (SwitchDim2):

SwD1: light level

short press: On/Off

long press: dimming

SwD2: scene selector (short press)

Colour&Dim

This operating mode is suitable for operating RGB—luminaires. Two DALI-addresses are used, the first to control the light level and the

second for changing the distribution on the output channels (e.g. for colour adjustments).

The Colour&Dim mode allows colour adjustments without affecting the light level and vice versa. For each channel only DALI-standard commands like dim up/down but also DAP are used. Thus the device can be used with all common controls and gateways (e.g. KNX). The Colour&Dim mode provides an alternative to the DT8-RGBWAF mode.

Can be operated via DALI or SwitchDim2:

DALI-address 1, SwD1: light level

DALI-address 2, SwD2: colour

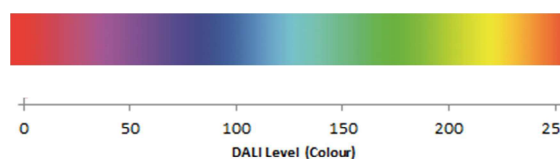

Selection of operating mode

With the help of the PC-software tool DALI-Cockpit the operating mode can be easily set on the general settings page.

Operating mode DT6:

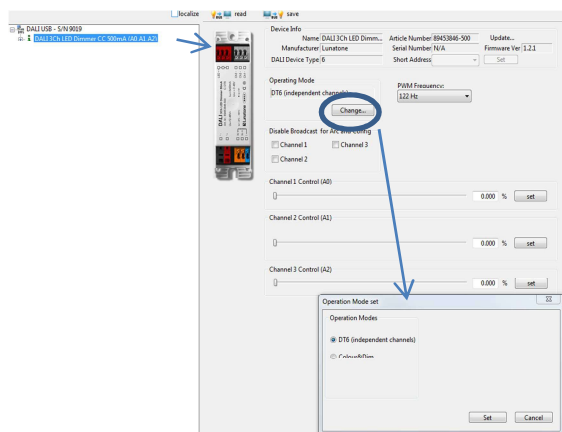

In addition, on the same page the PWM-frequency can be selected and basic control elements for testing each operating modes are available (3 sliders for the level of each channel in operating mode DT6 and slider for level and colour in the operating mode Colour&Dim). Furthermore the broadcast control can be deactivated for each channel individually.

Operating mode Colour&Dim:

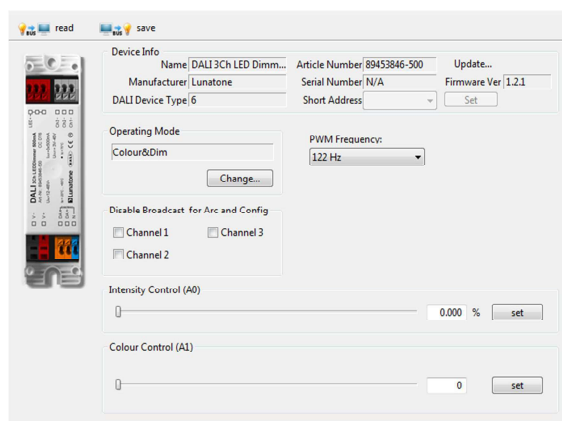

Switching between operating modes can also be done with the help of the DALI-command SET OPERATING MODE (IEC 62386-102 Ed.2). When changing the operating mode the number of used DALI-addresses can change as well and this requires a new addressing

procedure. In the DALI-Cockpit this address assignment is performed automatically.

Operating Mode:

Number	Operating Mode
0	DT6 (factory default)
0x90	DT6
0x93	Colour&Dim

Additional Settings

Besides the settings on the general page each channel can be selected separately in the component tree for individual configuration.

Component Tree:

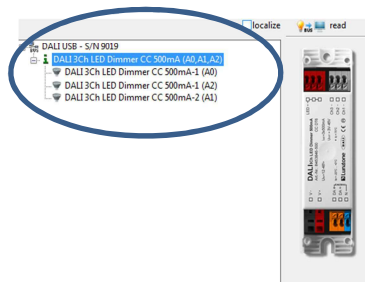

Settings for each channel (operating mode DT6 and Colour&Dim, in screenshot factory defaults are shown):

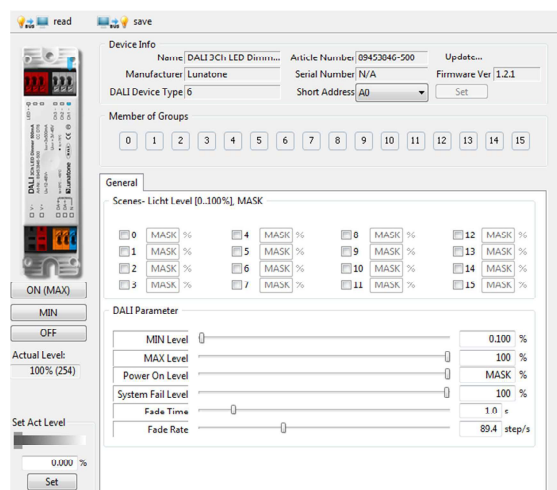

For each address the group membership can be set as well as scene values and DALI-parameters. In Colour&Dim operating mode,

all values assigned to channel 2 are representing colours.

Factory Default Settings

Before the initial addressing is performed, the device can already be controlled by a group address.

Summary of the factory default settings (delivery state):

Operating mode	DT6
SwitchDim2	SwD1: light level SwD2: scene selector
Min Level	0.1%
PowerOn Level	MASK (last value)
Fade Time	2 (1s)
Fade Rate	5 (89.4 steps/s)
PWM-frequency	auto
Groups before initial addressing:	G0 – channel1 G1 – channel2 G2 – channel3

Purchase Order Information

Art.Nr. 89453846-xxx: DALI 3Ch LED Dimmer, CC – constant current xxx mA (100mA-500mA), **common plus connector**, supply 12V-48V DC, output voltage range 3V-45V DC, **SwitchDim2**, remote ceiling & integration in luminaires

Art.Nr. 89453846-xxxGM: DALI 3Ch LED Dimmer, CC – constant current xxx mA (100mA-700mA), **common minus connector**, supply 12V-48V DC, output voltage range 3V-45V DC, **SwitchDim2**, remote ceiling & integration in luminaires

Additional Information and Equipment

DALI-Cockpit – free configuration tool from Lunatone for DALI systems

<http://lunatone.at/en/downloads/Lunatone-DALI-Cockpit.zip>

Lunatone DALI products

<http://www.lunatone.at/en/>

Lunatone datasheets and manuals

<http://lunatone.at/en/downloads/>

Contact

Technical Support: support@lunatone.com

Requests: sales@lunatone.com

www.lunatone.com



Disclaimer

Subject to change. Information provided without guarantee. The datasheet refers to the current delivery.

The compatibility with other devices must be tested in advance to the installation.