



Driver LCBI 10 W 180/350/500 mA PHASE-CUT/1-10 V SR basic series

Product description

- Independent dimmable LED Driver
- Constant current LED Driver
- Output current 180, 350 or 500 mA
- Max. output power 10 W
- Nominal life-time up to 50,000 h
- SELV
- Dimmable via leading edge and trailing edge phase dimmers
- Dimmable via 1 ... 10 V
- Output dimmed analogue (current amplitude)
- Dimming range typ. 10 to 100 % (depending on dimmer)
- For luminaires of protection class I and protection class II
- For luminaires with M and MM as per EN 60598, VDE 0710 and VDE 0711
- Temperature protection as per EN 61347-2-13 C5e
- 5-year guarantee

Properties

- Casing: polycarbonat, white
- Type of protection IP20
- Screw terminals



































Functions

- Overload protection
- Short-circuit protection
- No-load protection
- No output current overshoot at mains on/off



Standards, page 3

Wiring diagrams and installation examples, page 4

IP20 SELV                                                     
RoHS

Driver LCBI 10 W 180/350/500 mA PHASE-CUT/1-10 V SR basic series

Technical data

Rated supply voltage	220 – 240 V
AC voltage range	198 – 264 V
Typ. rated current (at 230 V, 50 Hz, full load)	0.058 A
λ at full load ^①	0.95
λ at min. load ^②	0.9
Mains frequency	50 Hz
Overvoltage protection	300 V AC, 1 h
Max. input power	13 W
Output power	5 – 10 W
THD (at 230 V, 50 Hz, full load)	< 20 %
THD (at 230 V, 50 Hz, min. load)	< 20 %
Control input ^③	1 ... 10 V, potentiometer 200 k Ω
Output current tolerance (at 230 V, 50 Hz, full load) ^④	\pm 7.5 %
Output current tolerance (at 230 V, 50 Hz, min. load) ^④	\pm 10 %
Starting time (at 230 V, 50 Hz, full load)	\leq 0.5 s
Turn off time (at 230 V, 50 Hz, full load)	\leq 0.2 s
Hold on time at power failure	0 s
Ambient temperature t_a	-20 ... +40 °C
Ambient temperature t_a (at life-time 50,000 h)	40 °C
Max. casing temperature t_c	60 °C
Storage temperature t_s	-40 ... +80 °C
Dimensions L x W x H	101.5 x 51 x 29.5 mm

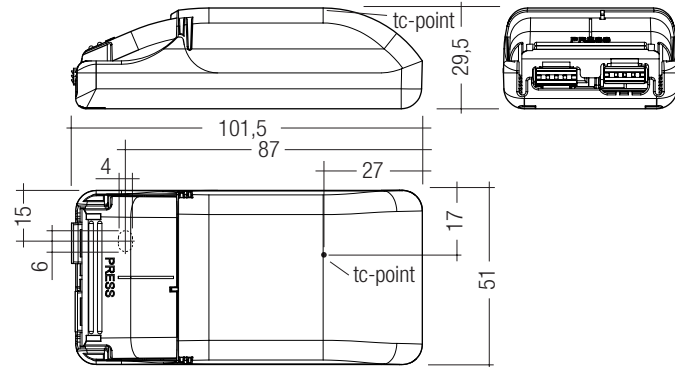

Ordering data

Type	Article number	Packaging, carton	Packaging, low volume	Packaging, high volume	Weight per pc.
LCBI 10W 180mA PHASE-CUT/1-10 V SR	87500273	20 pc(s).	280 pc(s).	3,360 pc(s).	0.088 kg
LCBI 10W 350mA PHASE-CUT/1-10 V SR	87500274	20 pc(s).	280 pc(s).	3,360 pc(s).	0.086 kg
LCBI 10W 500mA PHASE-CUT/1-10 V SR	87500275	20 pc(s).	280 pc(s).	3,360 pc(s).	0.085 kg

Specific technical data

Type	Output current ^⑤	Efficiency at full load ^⑥	Efficiency at min. load ^⑥	Min. forward voltage ^⑥	Max. forward voltage ^⑥	Max. output voltage	Max. repetitive output current at full load	Max. repetitive output peak current at min. load	Max. non-repetitive output peak current at full load	Max. non-repetitive output peak current at min. load	Typ. current ripple (at 230 V, 50 Hz, full load)
LCBI 10W 180mA PHASE-CUT/1-10 V SR	180 mA	77 %	72 %	28 V	56 V	65 V	270 mA	320 mA	270 mA	320 mA	\pm 25 %
LCBI 10W 350mA PHASE-CUT/1-10 V SR	350 mA	76 %	72 %	14 V	28 V	45 V	510 mA	620 mA	580 mA	620 mA	\pm 30 %
LCBI 10W 500mA PHASE-CUT/1-10 V SR	500 mA	74 %	70 %	10 V	20 V	35 V	760 mA	890 mA	760 mA	890 mA	\pm 35 %

^① Test result at 230 V, 50 Hz without dimmer connected.

^② 1 ... 10 V DC source with double or reinforced insulation with respect to AC mains. Max. source current: 0.1 mA. Suitable for passiv and active control.

^④ Output current is mean value.

Standards

EN 55015
EN 61000-3-2
EN 61000-3-3
EN 61347-1
EN 61347-2-13
EN 61547
EN 62384

Overload protection

If the output voltage range is exceeded the LED Driver reduces the LED output current. After elimination of the overload the nominal operation is restored automatically.

Short-circuit behaviour

In case of a short circuit on the secondary side (LED) the LED Driver switches off. After elimination of the short circuit the nominal operation is restored automatically.

No-load operation

The LED Driver works in burst working mode to provide a constant output voltage regulation which allows the application to be able to work safely when LED string open due a failure.

In no-load operation the output voltage will not exceed the specified max. output voltage (see page 2).

Expected life-time

Type	ta	40 °C	50 °C
LCBI 10W xxxmA PHASE-CUT/1-10 V SR	tc	60 °C	x
	Life-time	50,000h	x

The LED Drivers are designed for a life-time stated above under reference conditions and with a failure probability of less than 10 %.

Maximum loading of automatic circuit breakers

Automatic circuit breaker type	C10	C13	C16	C20	B10	B13	B16	B20	Inrush current	
									Installation Ø	1.5 mm ²
LCBI 10W 180mA PHASE-CUT/1-10 V SR	60	90	120	140	30	45	60	70	10 A	100 µs
LCBI 10W 350mA PHASE-CUT/1-10 V SR	60	90	120	140	30	45	60	70	10 A	100 µs
LCBI 10W 500mA PHASE-CUT/1-10 V SR	60	90	120	140	30	45	60	70	10 A	100 µs

Harmonic distortion in the mains supply (at 230 V / 50 Hz and full load) in %

	THD	3.	5.	7.	9.	11.
LCBI 10W 180mA PHASE-CUT/1-10 V SR	20	9	10	7	5	3
LCBI 10W 350mA PHASE-CUT/1-10 V SR	20	10	10	7	5	3
LCBI 10W 500mA PHASE-CUT/1-10 V SR	20	11	10	7	5	3

Installation instructions

The LED module and all contact points within the wiring must be sufficiently insulated against 2.8 kV surge voltage.

Air and creepage distance must be maintained.

Replace LED module

1. Mains off
2. Remove LED module
3. Wait for 20 seconds
4. Connect LED module again

Hot plug-in or secondary switching of LEDs is not permitted and may cause a very high current to the LEDs.

Dimming

Dimming range 10 % to 100 %

Control with:

- Potentiometer
- 1 ... 10 V
- Both phase cut and 1 ... 10 V dimmer connect together in one device is not permitted and may cause flicker.
- In 1 ... 10 V dimming applications, the system SELV depends on the dimmer. If a SELV 1 ... 10 V dimmer is used, the system will be SELV.
- Wrong polarity input to the 1 – 10 V interface will damage the LED Driver.

1 ... 10 V function

The light intensity of the LEDs vary proportionally to the signal sent to the terminal.

Potentiometer function

By rotating the potentiometer there is variation of the LED light intensity in a proportionate or logarithmic way depending on the model of potentiometer used. The use of a logarithmic potentiometer is recommended.

Humidity: 5 % up to max. 85 %, not condensed (max. 56 days/year at 85 %)

Storage temperature: -40 °C up to max. +80 °C

The devices have to be within the specified temperature range (ta) before they can be operated.

Glow wire test

according to EN 60598-1 with increased temperature of 850 °C passed.

Wiring type and cross section

The wiring can be in stranded wires with ferrules or solid. For perfect function of the cage clamp terminals the strip length should be 4 – 5 mm for the input terminal.

The max. torque at the clamping screw (M3) is 0.2 Nm.

Input terminal (D2)

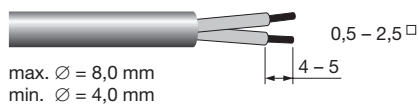

Output terminal (D1)

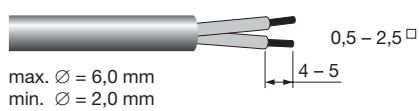

To get a proper working strain relief it is recommended that the cable jacket diameter of the side D2 is 2 mm bigger than the diameter of the side D1. (This can vary if the used cable jacket material varies from side D2 to D1 in pinching property).

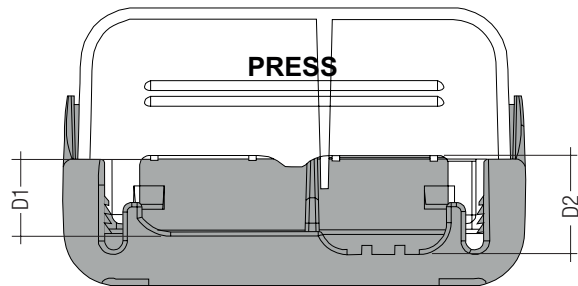

Depending on the used flaps of the terminal following cable jacket diameter difference between the side D2 and D1 terminals is recommended:

Side D1		Side D2		Difference D2 - D1		
Housing bottom	Cover terminal	With flap	Without flap			
With flap	Without flap	With flap	Without flap	With flap	Without flap	
x	-	x	-	x	-	3.5 mm
x	-	x	-	-	x	5.5 mm
x	-	-	x	-	x	3.5 mm
-	x	x	-	-	x	3.5 mm
-	x	-	x	-	x	1.5 mm
x	-	-	x	x	-	1.5 mm
-	x	x	-	x	-	1.5 mm
-	x	-	x	x	-	-0.5 mm

Wiring guidelines

- All connections must be kept as short as possible to ensure good EMI behaviour.
- Mains leads should be kept apart from LED Driver and other leads (ideally 5 – 10 cm distance)
- Max. length of output wires is 2 m.
- The secondary wires (LED module) should be routed in parallel to ensure good EMC performance.
- Secondary switching is not permitted.
- Through wiring is not possible.
- Incorrect wiring can damage LED modules.
- To avoid the damage of the Driver, the wiring must be protected against short circuits to earth (sharp edged metal parts, metal cable clips, louver, etc.).

Fixing conditions

Dry, acidfree, oilfree, fatfree. It is not allowed to exceed the maximum ambient temperature (ta) stated on the device. Minimum distances stated below are recommendations and depend on the actual luminaire. Is not suitable for fixing in corner.

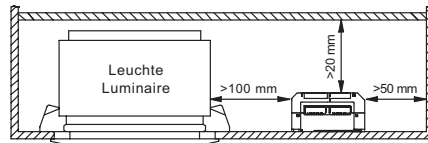

Wiring diagram

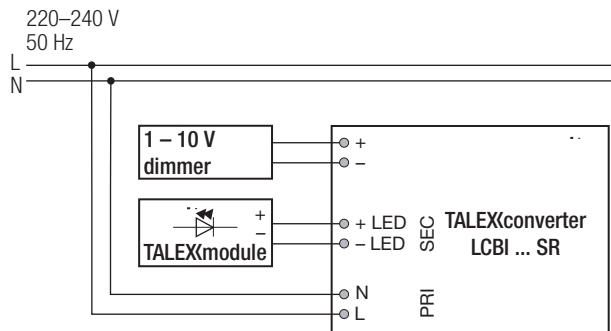
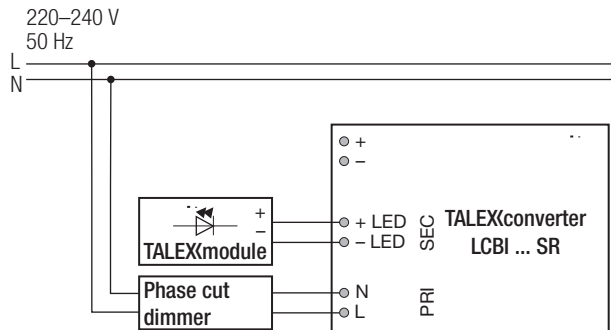

Isolation and electric strength testing of luminaires

Electronic devices can be damaged by high voltage. This has to be considered during the routine testing of the luminaires in production.

According to IEC 60598-1 Annex Q (informative only!) or ENEC 303-Annex A, each luminaire should be submitted to an isolation test with 500 V_{DC} for 1 second. This test voltage should be connected between the interconnected phase and neutral terminals and the earth terminal. The isolation resistance must be at least 2 MΩ.

As an alternative, IEC 60598-1 Annex Q describes a test of the electrical strength with 1500 V_{AC} (Or 1.414 x 1500 V_{DC}). To avoid damage to the electronic devices this test must not be conducted.

Additional information

Additional technical information at www.tridonic.com → Technical Data

Guarantee conditions at www.tridonic.com → Services

Life-time declarations are informative and represent no warranty claim. No warranty if device was opened.

Diagrams LCBI 10W 180mA PHASE-CUT/1-10 V SR

Efficiency vs load

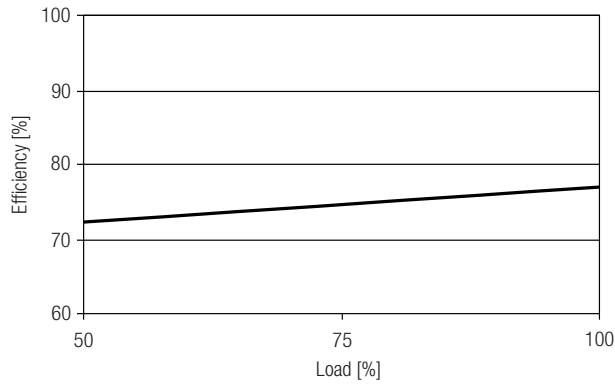

Power factor vs load

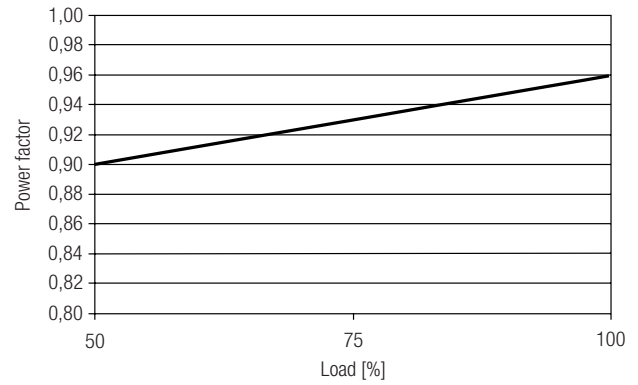

THD vs load

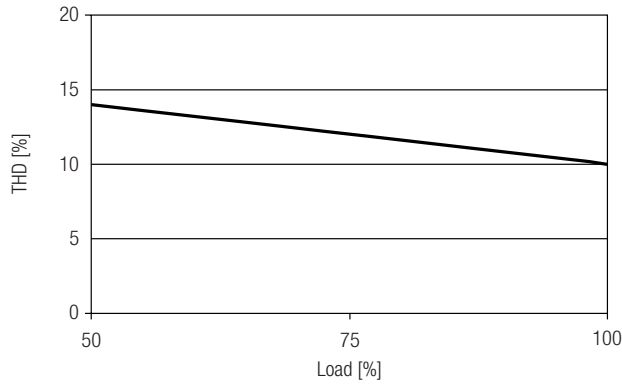

Input current vs load

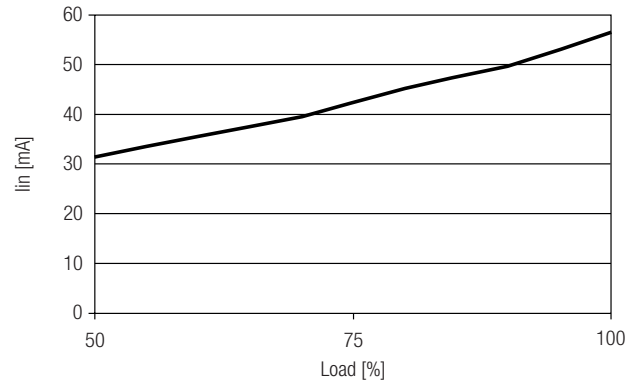

Input power vs load

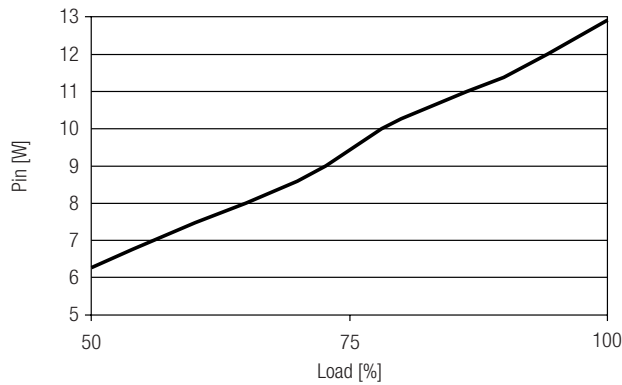

Output current vs dimming resistance

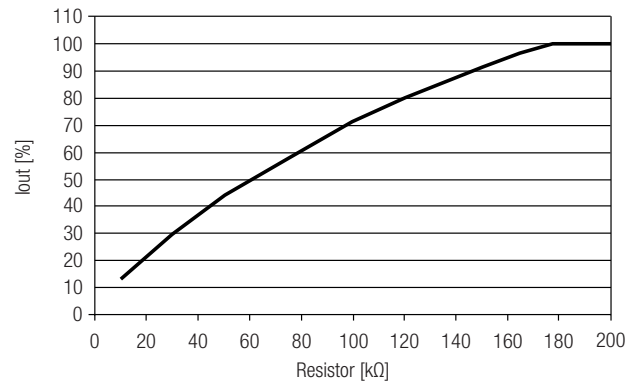

Phase cut dimming curve (depends dimmer)
Output current vs dimming angle

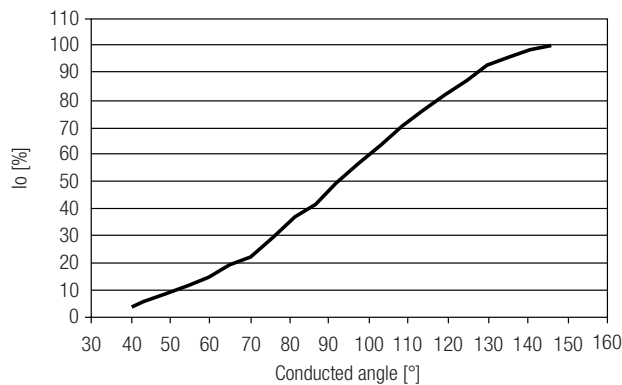

1 - 10 V dimming curve
Output current vs dimming voltage

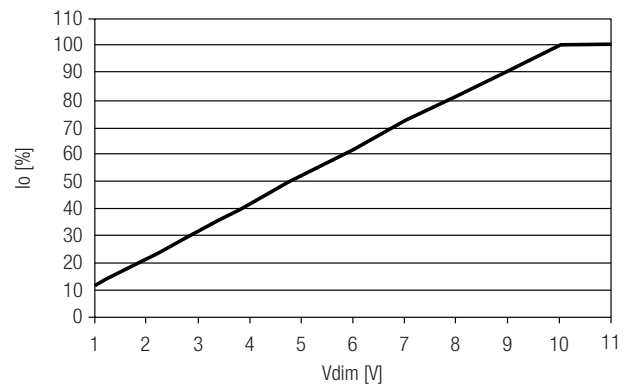

Diagrams LCBI 10W 350mA PHASE-CUT/1-10 V SR

Efficiency vs load

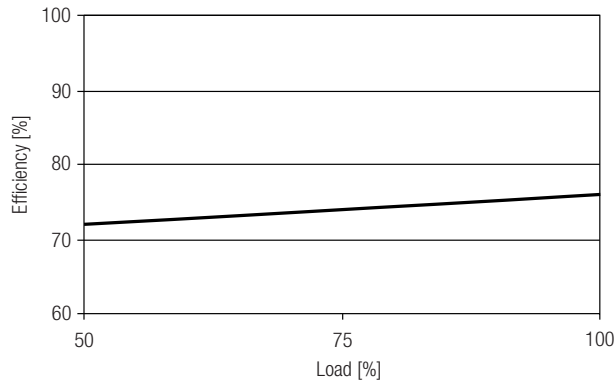

Power factor vs load

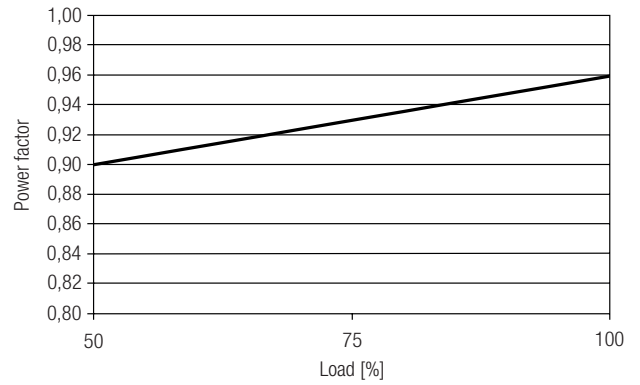

THD vs load

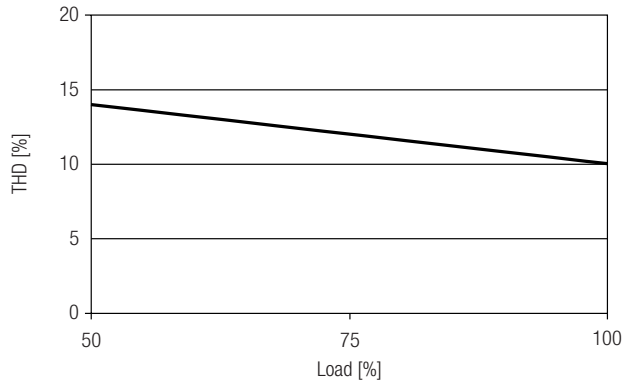

Input current vs load

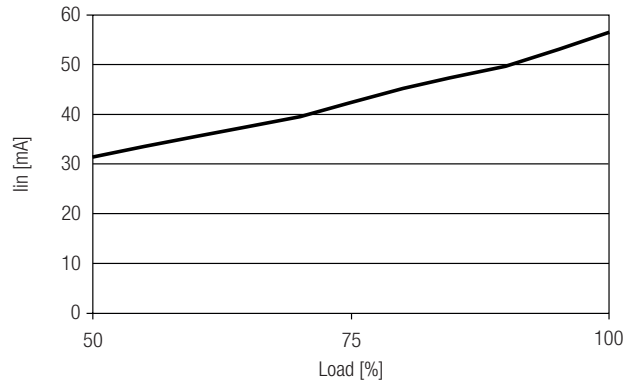

Input power vs load

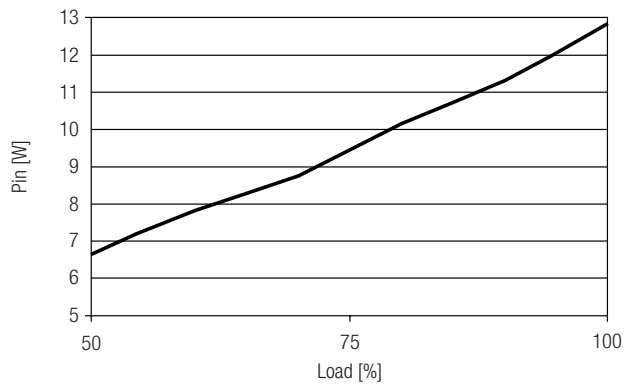

Output current vs dimming resistance

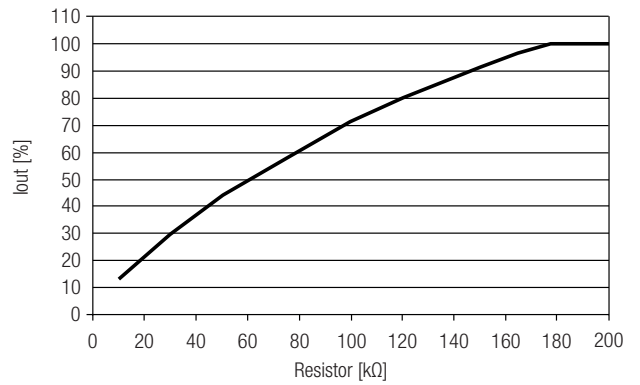

Phase cut dimming curve (depends dimmer)
Output current vs dimming angle

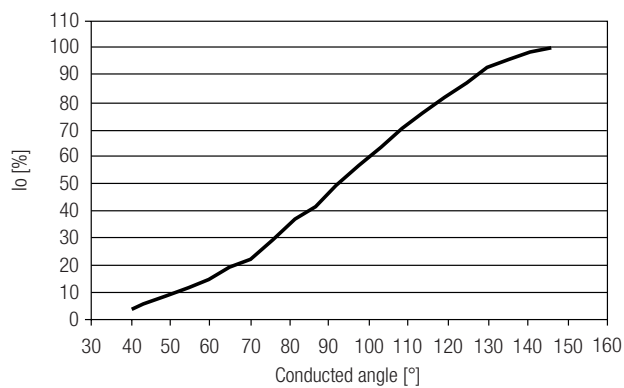

1 - 10 V dimming curve
Output current vs dimming voltage

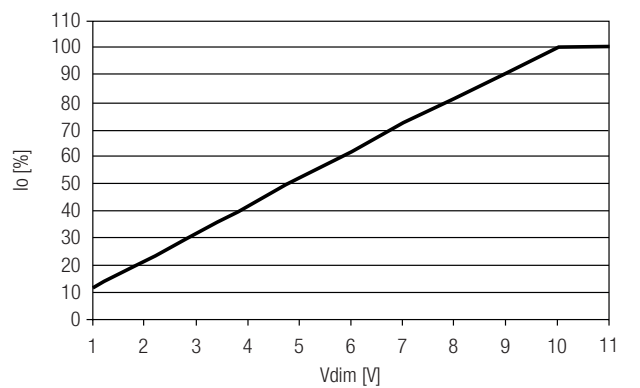

Diagrams LCBI 10W 500mA PHASE-CUT/1-10 V SR

Efficiency vs load

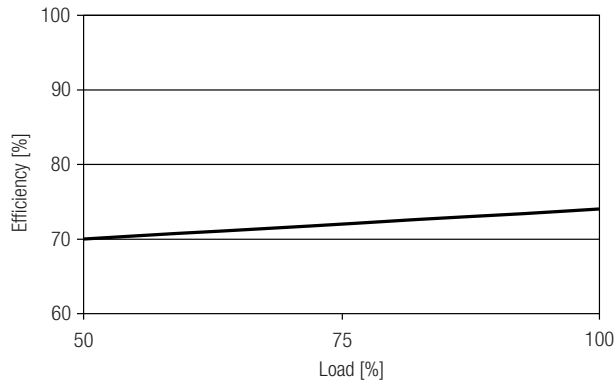

Power factor vs load

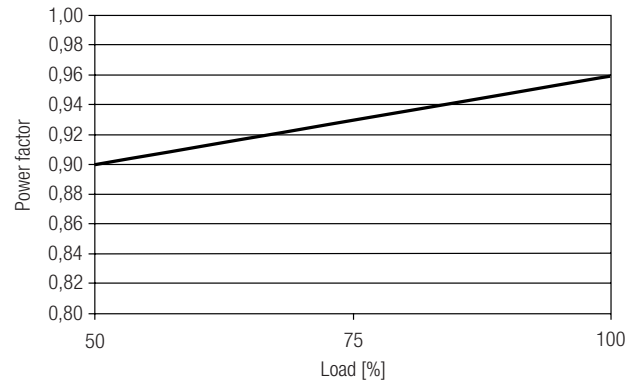

THD vs load

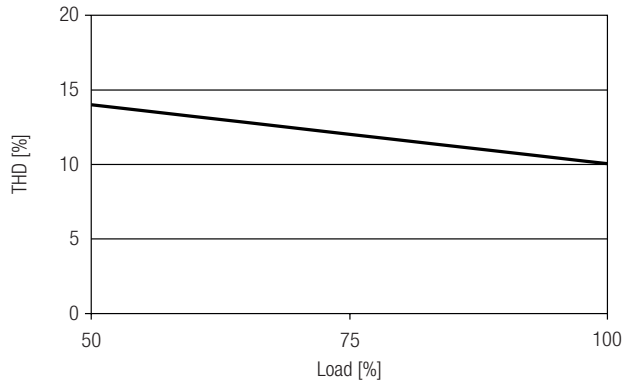

Input current vs load

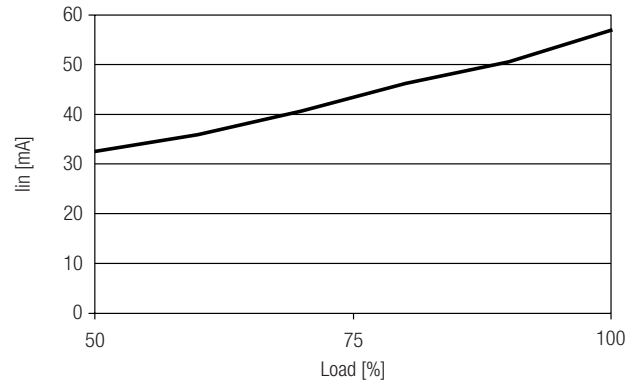

Input power vs load

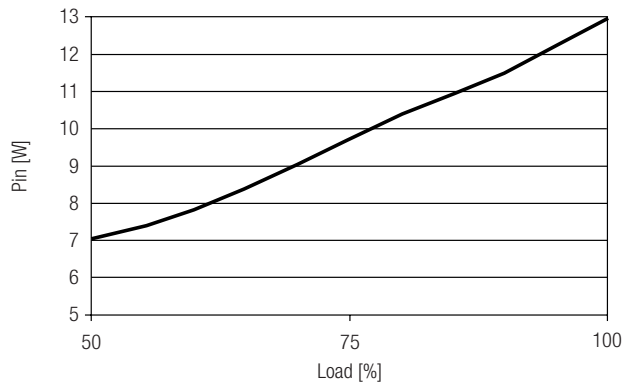

Output current vs dimming resistance

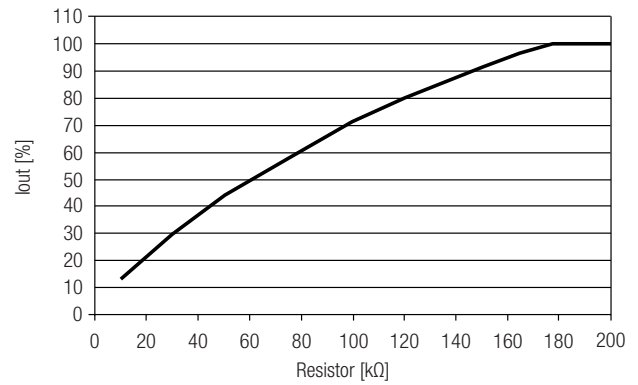

Phase cut dimming curve (depends dimmer)
Output current vs dimming angle

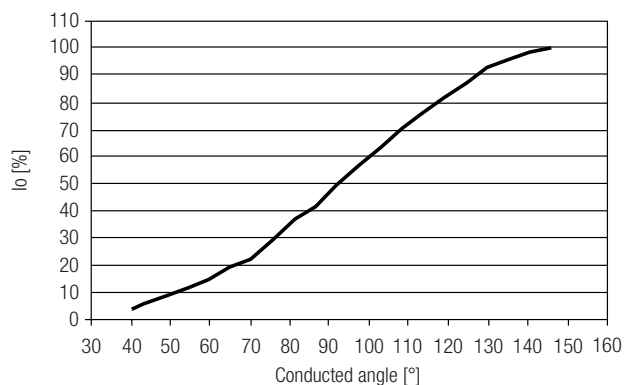

1 - 10 V dimming curve
Output current vs dimming voltage

